

TECHNICAL DRAWINGS

JSC RUSTICLAD Horizontal Weatherboards Flexible Underlay 20mm Cavity Fix

ISSUE : 11/02/2026 | VERSION : 2.6

© J SCOTT & COMPANY LIMITED 2026

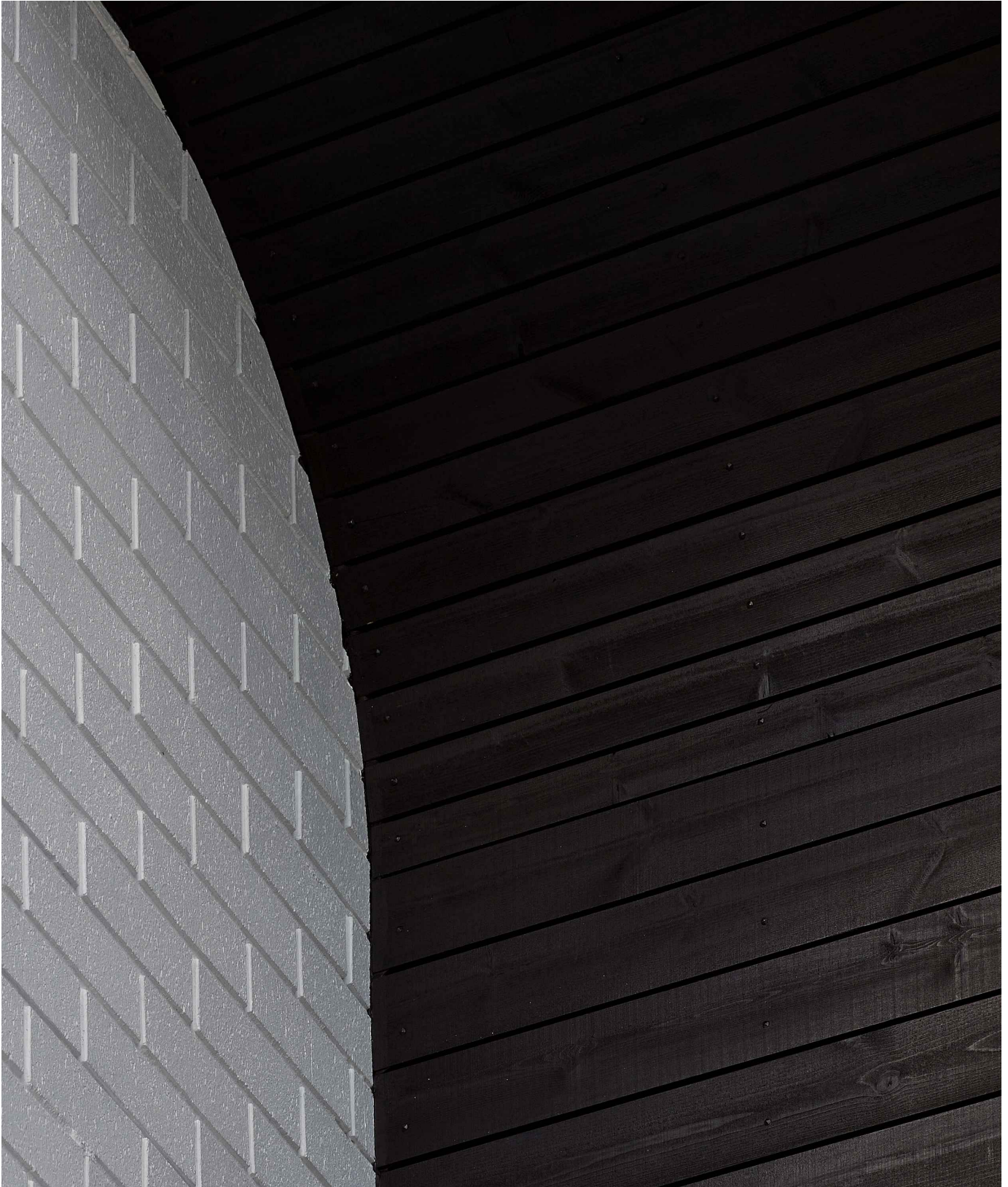

Photo: Huia Road Townhouses, Point Chevalier | Method Group

CodeMark
CMNZ30081

JSC PREMIUM ARCHITECTURAL
& BUILDING SOLUTIONS

jsc.co.nz
TechHelp@jsc.co.nz | (09) 412 2812

TYPE
RUSTICATED WB - 20MM CAVITY FIX

NAME
COVER SHEET

- TO BE READ IN CONJUNCTION WITH COMPLETE JSC RUSTICLAD SYSTEM LITERATURE
- DETAILS MAY BE SUBJECT CHANGE WITHOUT NOTICE



SCAN IT FOR MORE
INFORMATION

DRAWING SCALE NTS	ISSUE DATE 11/02/2026
DRAWING NUMBER JSC 20CF RC01	VERSION 2.6

INDEX

ISSUE : 11/02/2026 | VERSION : 2.6

© J SCOTT & COMPANY LIMITED 2026

Sheet Number	Sheet Title
JSC 20CF RC01	COVER SHEET
JSC 20CF RC02	INDEX
JSC 20CF RC03	GENERAL NOTES
JSC 20CF RC04	RELATED DOCUMENTS
JSC 20CF RC10	Window Head Detail
JSC 20CF RC11	Window Sill Detail
JSC 20CF RC12	Window Jamb Detail - Scriber
JSC 20CF RC13	Window Jamb Detail - No Scriber
JSC 20CF RC30	Square Utility Head Detail
JSC 20CF RC31	Square Utility Sill Detail
JSC 20CF RC32	Square Utility Jamb Detail
JSC 20CF RC40	Weatherboard Scarf Joint
JSC 20CF RC41	Vertical Control Joint
JSC 20CF RC42	Base of Wall, Concrete
JSC 20CF RC43	Base of Wall, Timber
JSC 20CF RC44	Pipe Penetration
JSC 20CF RC50	External Corner- Box Corner
JSC 20CF RC51	3D - External Corner- Box Corner
JSC 20CF RC52	External Corner - J42
JSC 20CF RC53	3D - External Corner - J42
JSC 20CF RC60	Internal Corner - J44
JSC 20CF RC61	3D - Internal Corner- J44
JSC 20CF RC62	Internal Corner
JSC 20CF RC63	3D - Internal Corner
JSC 20CF RC70	Base of Wall, Membrane Roof
JSC 20CF RC71a	Parapet Saddle Flashing - Stage One
JSC 20CF RC71b	Parapet Saddle Flashing - Stage Two
JSC 20CF RC71c	Parapet Saddle Flashing - Stage Three
JSC 20CF RC71d	Parapet Saddle Flashing - Stage Four
JSC 20CF RC75	Parapet Detail
JSC 20CF RC77	Decorative Bracket - Batten Detail
JSC 20CF RC80	Inter Storey Joint
JSC 20CF RC81	Apron Flashing Roof to Wall Junction
JSC 20CF RC82	Soffit Detail at Wall
JSC 20CF RC83	Soffit Detail at Fascia
JSC 20CF RC84	Raking Soffit at Wall
JSC 20CF RC85	Gable Soffit Detail at Wall
JSC 20CF RC90	Weatherboard Fixing - Plan
JSC 20CF RC91	Weatherboard Fixing - Cross Section
JSC 20CF RC92	Apron Flashing Gutter to Wall

CodeMark
CMNZ30081



JSC PREMIUM ARCHITECTURAL
& BUILDING SOLUTIONS

jsc.co.nz
TechHelp@jsc.co.nz | (09) 412 2812

TYPE
RUSTICATED WB - 20MM CAVITY FIX

NAME
INDEX

• TO BE READ IN CONJUNCTION WITH COMPLETE JSC RUSTICLAD SYSTEM LITERATURE
• DETAILS MAY BE SUBJECT CHANGE WITHOUT NOTICE



SCAN IT FOR MORE
INFORMATION

DRAWING SCALE | ISSUE DATE
NTS | 11/02/2026

DRAWING NUMBER | VERSION
JSC 20CF RC02 | 2.6

GENERAL NOTES

ISSUE : 11/02/2026 | VERSION : 2.6

© J SCOTT & COMPANY LIMITED 2026

OVERVIEW :

JSC RustiClad is a cavity based external wall cladding system comprising of:

- Timber weatherboards finished with high quality exterior grade coating
- H3.2 treated timber castellated cavity battens
- Fascia boards and moulding profiles

This documentation covers the installation guide for fixing JSC Rusticated weatherboards over JSC-U 45x20mm non-structural cavity battens.

SCOPE OF USE:

- This document is for use within the scope of JSC RustiClad Rusticated Weatherboard Cladding System technical documentation and Code Compliance CodeMark certificate [CMNZ 3081](#).
- For scope, conditions and limitations of use refer to CodeMark certificate [CMNZ 3081](#).
- Details are subject to change without notification and only the current version is compliant. Refer to [jsc.co.nz](#) at the time of use for the current documentation.
- The designer/specifier must be satisfied that these details are applicable for their intended use.

FIXING SPECIFICATION:

- Western Red Cedar, Alaskan Yellow Cedar, Radiata Pine, Nordic Pine, TMT Taiga, TMT Taxon, TMT Tuscan, TMT Amba, TMT ThermoPine and TMT ThermoPine H3.2 MicroPro treated: Fixing material to be 316 stainless steel or silicon bronze nails.
- For the use of any alternative fixing of equivalent properties refer to [E2/AS1 C.3.1.1](#) and to [E2/AS1 Table C.1.1.1A](#) for alternative material selection.
- JSC recommends nail materials as per [RustiClad Installation Guide Table 3 - Nail Fixings](#), as they will at least match the expected life of the cladding. E2/AS1 allows the use of galvanised fixings, although JSC does not endorse their use.
- Jolt head nails are only suitable for paint finished weatherboards.
- For buildings located in exposure 'Zone D', 316 stainless steel fixings must be used as per NZS3604:2011.

PRE INSTALLATION:

- Weatherboards must be dry and free of any contamination.
- Board lengths must be optimised prior to the installation to avoid any unnecessary wastage and joints.
- Any loose, bark encased knots, or other timber defects need to be removed.
- Weatherboards must be coated with suitable exterior coating on all sides in accordance with coating manufacturer's specification.

INSTALLATION:

- JSC RustiClad System must be installed by a suitably qualified and experienced trade person. Where Restricted Building Work (RBW) applied the installer shall be a Licensed Building Practitioner (LBP) or supervised by LBP.
- Compatibility of materials as per [Tables C.1.1.1A / B / C E2/AS1](#).
- Rigid and flexible underlay as per [Table C.2.1.1](#) and [Clauses 9.1.4 to 9.1.6 E2/AS1](#) or proprietary approved alternative.
- The weatherboard system shall incorporate joinery that meets the requirements of New Zealand Building Code for the relevant building wind zone or wind pressure.
- Where weatherboards have an exposed bottom edge, the back of the boards should be cut with a 15° drip edge and the cut end should be coated to 150-200mm up from the bottom edge.
- Cavity closer/vermin proofing must be installed continuously around the bottom of the cavity positioned to give a 15mm min. drip edge to cladding.
- Cavity closer/vermin proofing openings must be kept clear and unobstructed to maintain draining and venting of the cavity.
- Windows and doors to be installed as per manufacturer's specifications, head flashing stop ends must be in place. Flashings as per [Clause 4.0 E2/AS1](#).
- Flashings as per [Clause 4.0 E2/AS1](#) at corners, doors, windows and wall intersections must be installed to prevent water from crossing the cavity.
- Sealant to be compatible with the final coating system and to be applied as per manufacturer's instructions and specifications. For JSC Coating products refer to [JSC Coatings Wood Oil Range Guide](#).

MAINTENANCE:

- Annual inspection and cleaning followed by repair to any damaged areas. Refer to [JSC Maintenance Guide](#).

CodeMark
CMNZ30081

JSC PREMIUM ARCHITECTURAL & BUILDING SOLUTIONS

[jsc.co.nz](#)
TechHelp@jsc.co.nz | (09) 412 2812

TYPE
RUSTICATED WB - 20MM CAVITY FIX

NAME
GENERAL NOTES

• TO BE READ IN CONJUNCTION WITH COMPLETE JSC RUSTICLAD SYSTEM LITERATURE
• DETAILS MAY BE SUBJECT CHANGE WITHOUT NOTICE



SCAN IT FOR MORE INFORMATION

DRAWING SCALE NTS	ISSUE DATE 11/02/2026
DRAWING NUMBER JSC 20CF RC03	VERSION 2.6

RELATED DOCUMENTS

ISSUE : 11/02/2026 | VERSION : 2.6

- MBIE NZ Building Code Clause E2 External Moisture (refer to [E2 External moisture](#))
- Department of Building and Housing (DBH). [Constructing cavities for wall claddings.](#)
- BRANZ Bulletin BU468 [December 2005] Fixing Timber Weatherboards (refer to www.branz.co.nz/BU468)
- [BRANZ Good Practice Guide: Timber Cladding](#)
- [BRANZ Build 154-33 - Build Right Structurally Fixed Cavity Battens](#)
- [BRANZ Build 173-28 - Build Right Coatings for Timber Weatherboards](#)
- [BRANZ Bulletin BU531 Designing for Thermal and moisture Movement](#)
- Window & Glass Association NZ - WGANZ (www.wganz.org.nz)
- [NZS AS 1720.1:2022](#)
- [NZS 3604:2011 Timber- framed buildings](#)

Disclaimer: It is the responsibility of the designer/specifier to ensure the suitability and specification of any third-party accessories used with our cladding system. JSC is not liable for the installation of any components or accessories not supplied by us. For guidance on using specific components, please refer to our Technical Installation Details and Installation Guides. If there is any uncertainty, please seek expert advice.

The related documents mentioned above were accurate and up to date at the time of writing this guide. However, please note that information may have changed since then, and we recommend verifying any external sources for the most current information.

CodeMark
CMNZ30081



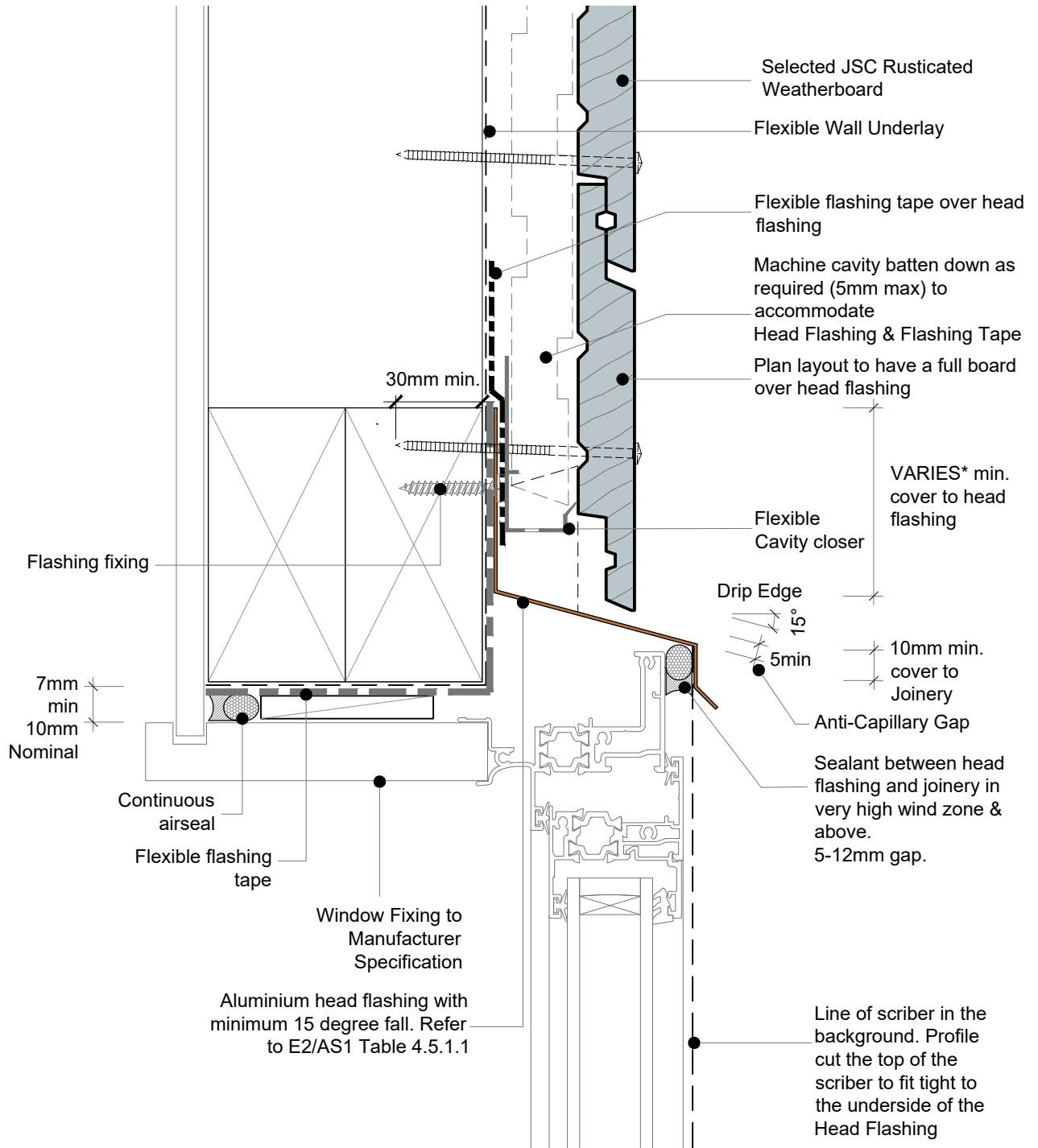

NOTES:

- Ensure a minimum penetration of 30mm into the timber frame due to the presence of multiple elements, including cavity batten, flashing tape, cavity closure, and head flashing.
- To address the buildup of elements on the head detail, consider the use of a flexible cavity closer.

*JSC recommends no hooks or hems. Therefore, the flashing upstand dimensions must be increased by 25 mm in accordance with E2/AS1, Section 4.4.3



DRAWING SCALE 1:2 @ A4	ISSUE DATE 11/02/2026
DRAWING NUMBER JSC 20CF RC10	VERSION 2.6

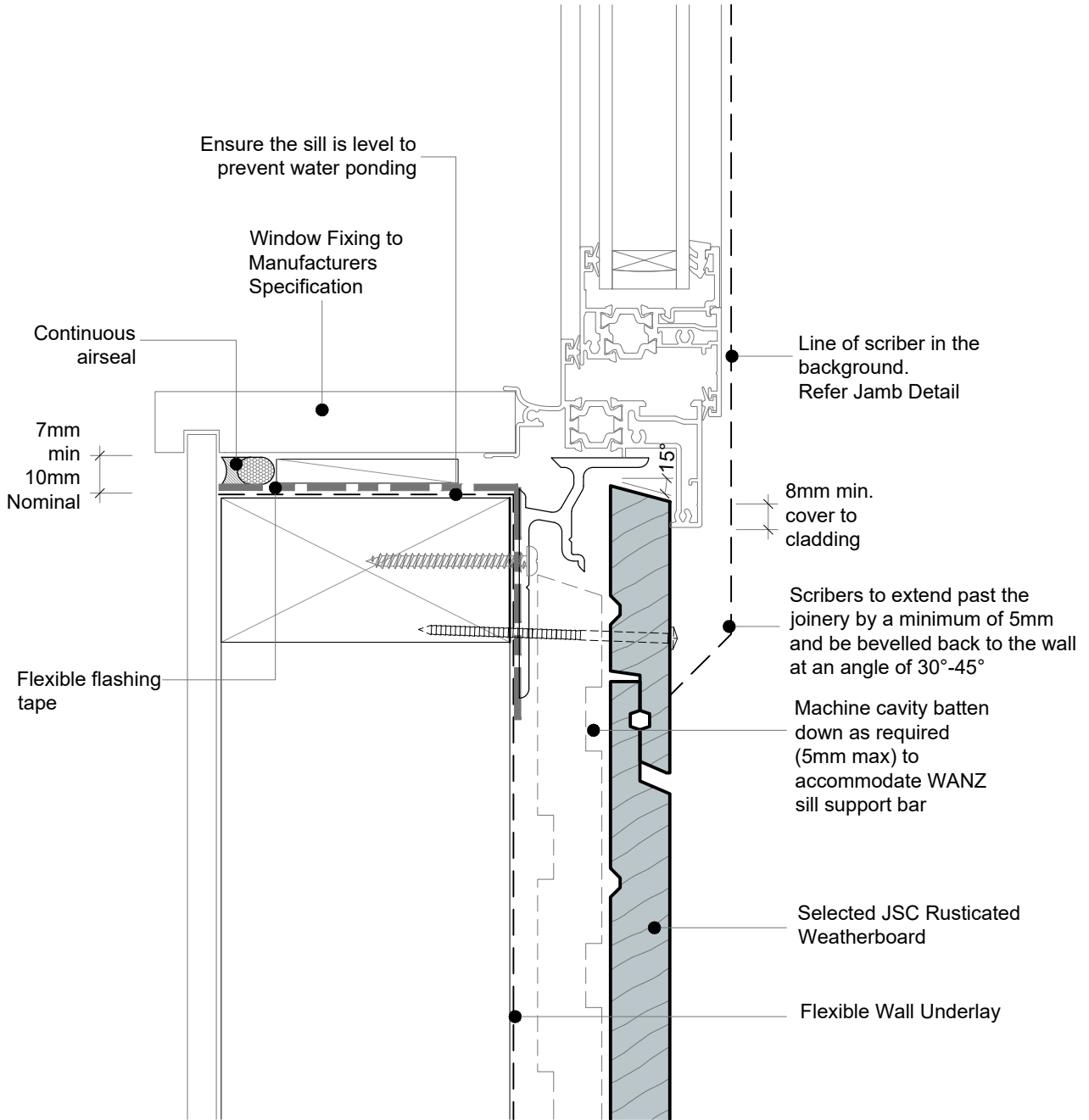

DRAWING SCALE 1:2 @ A4	ISSUE DATE 11/02/2026
DRAWING NUMBER JSC 20CF RC11	VERSION 2.6

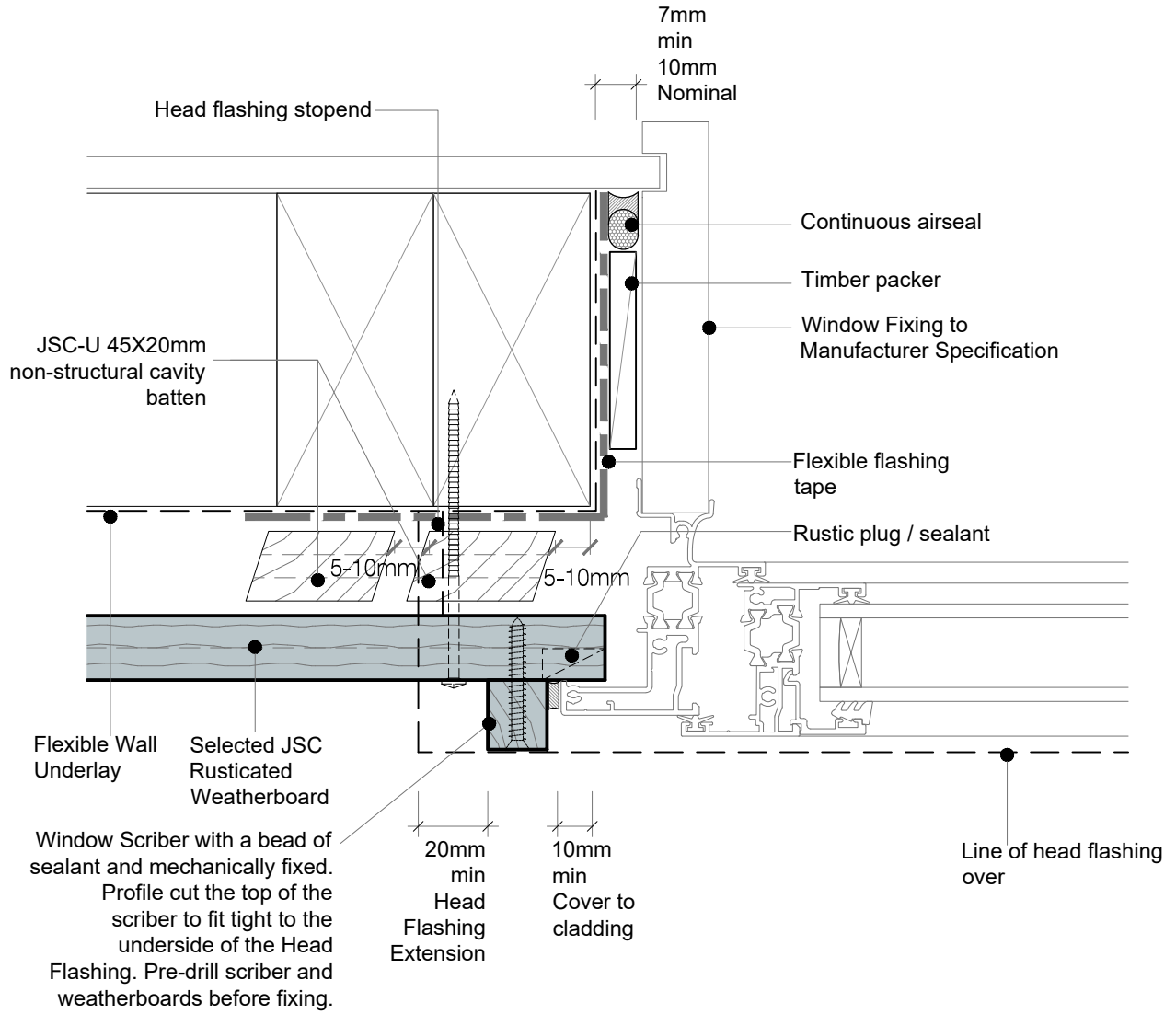

DRAWING SCALE 1:2 @ A4	ISSUE DATE 11/02/2026
DRAWING NUMBER JSC 20CF RC12	VERSION 2.6

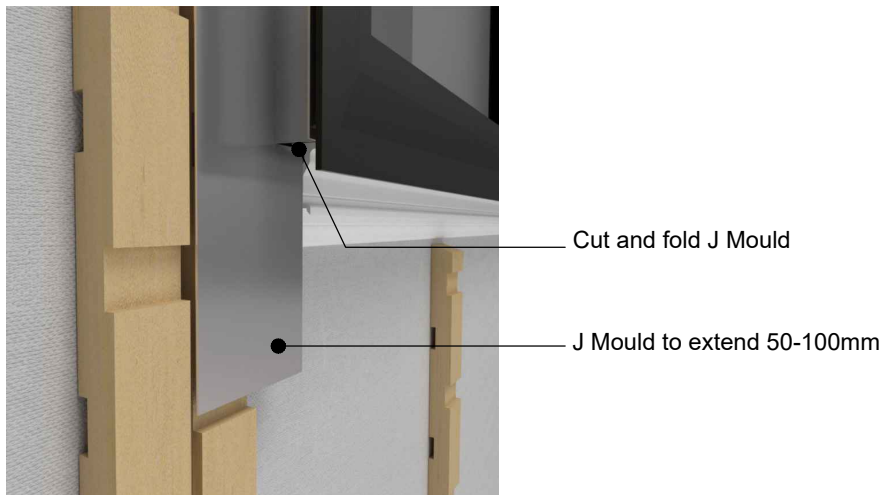
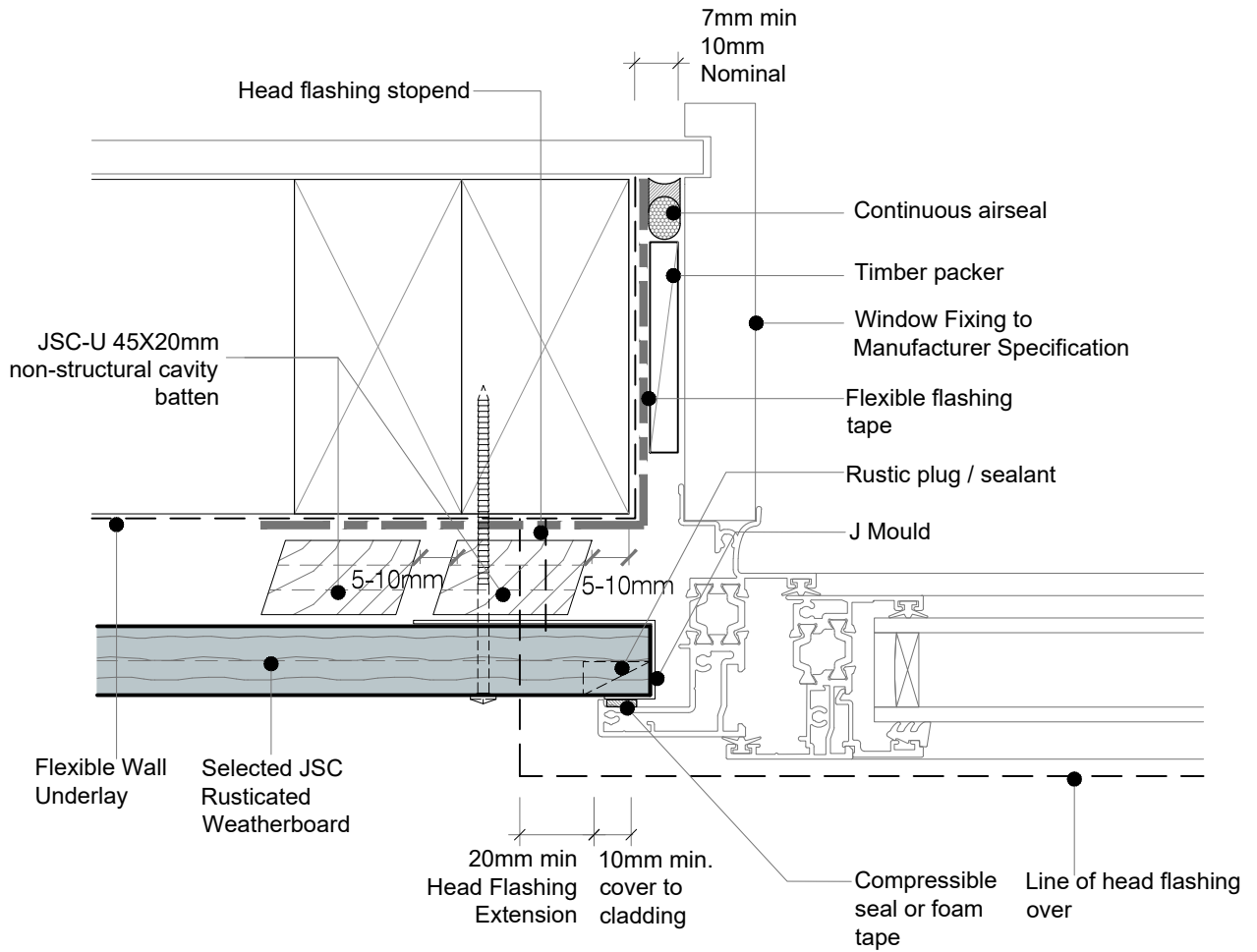

NOTE : No Scriber Option :
 The Aluminium Joinery must sit hard against the back of the joinery flange and the timber weatherboards with a seal or foam tape in between.



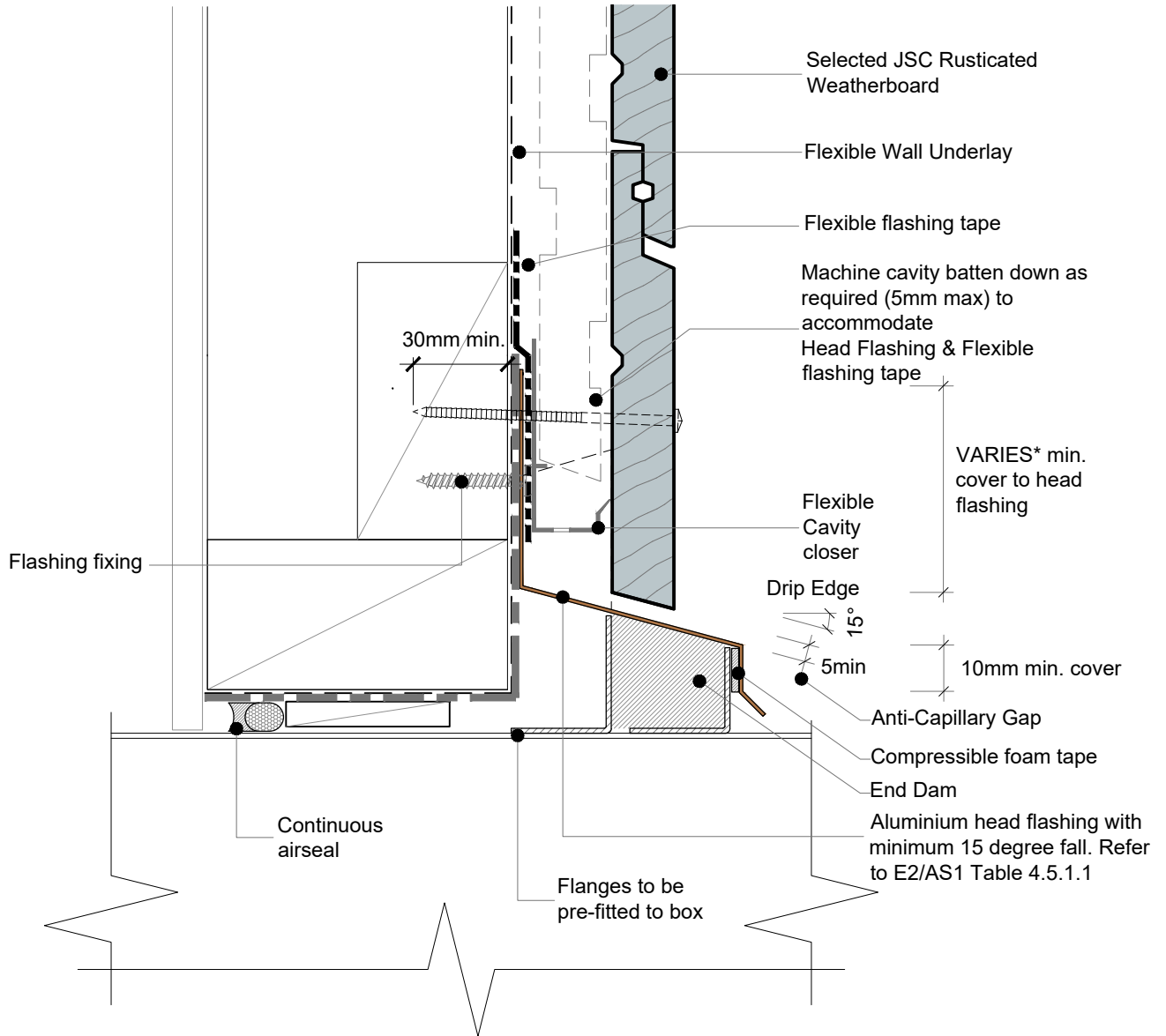

NOTE:

- Ensure a minimum penetration of 30mm into the timber frame due to the presence of multiple elements, including cavity batten, flashing tape, cavity closure, and head flashing.
- To address the buildup of elements on the head detail, consider the use of a flexible cavity closer.

*JSC recommends no hooks or hems. Therefore, the flashing upstand dimensions must be increased by 25 mm in accordance with E2/AS1, Section 4.4.3

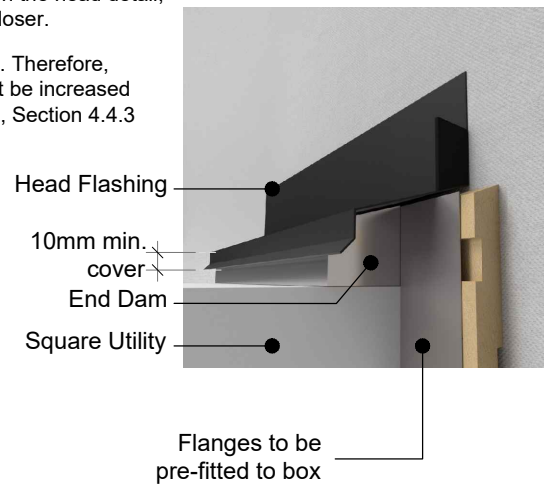
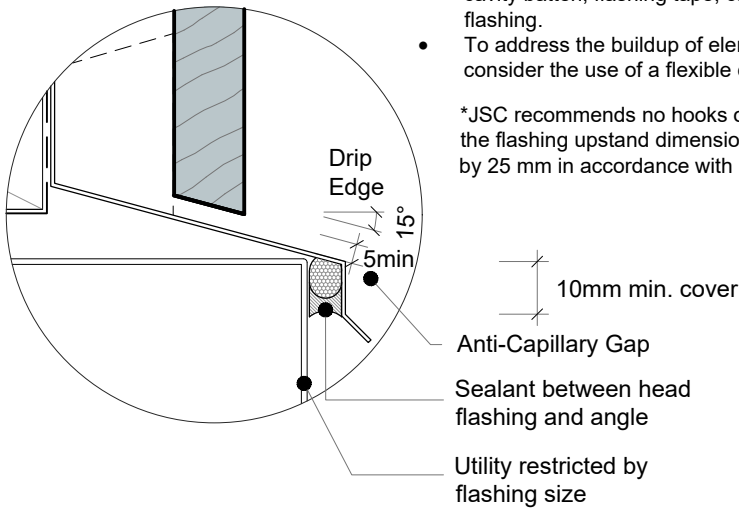

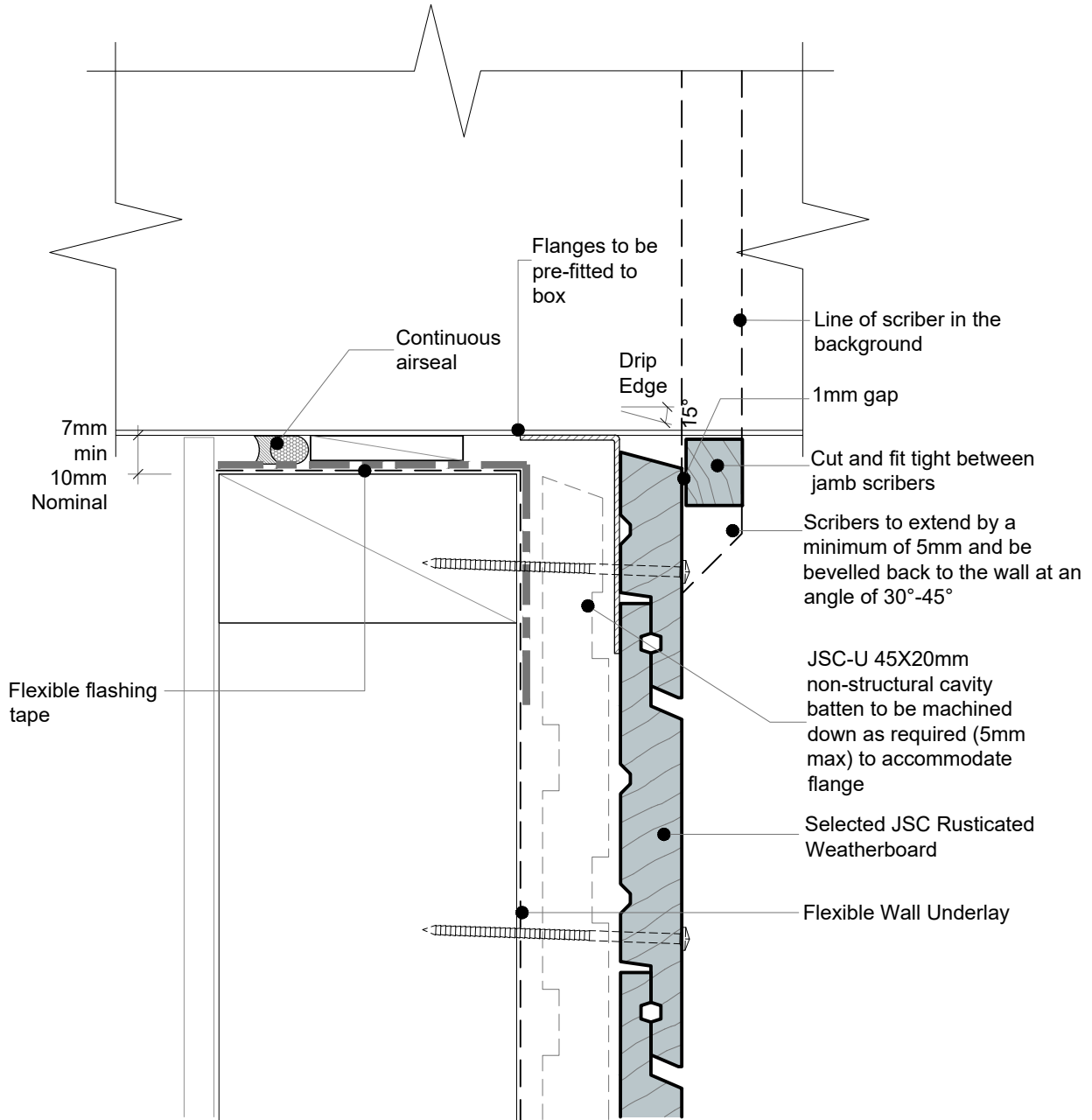

DRAWING SCALE 1:2 @ A4	ISSUE DATE 11/02/2026
DRAWING NUMBER JSC 20CF RC31	VERSION 2.6

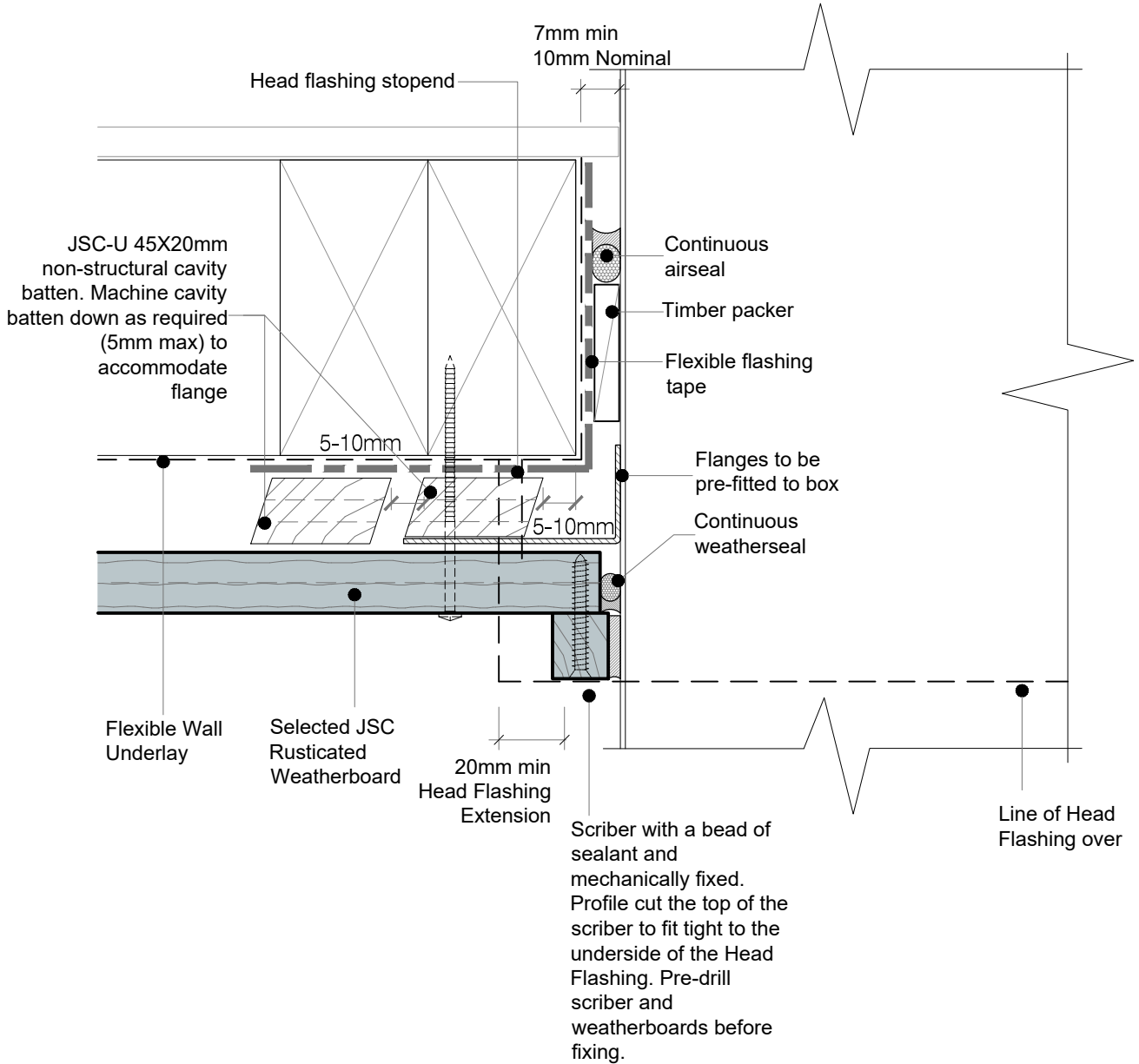

DRAWING SCALE 1:2 @ A4	ISSUE DATE 11/02/2026
DRAWING NUMBER JSC 20CF RC32	VERSION 2.6

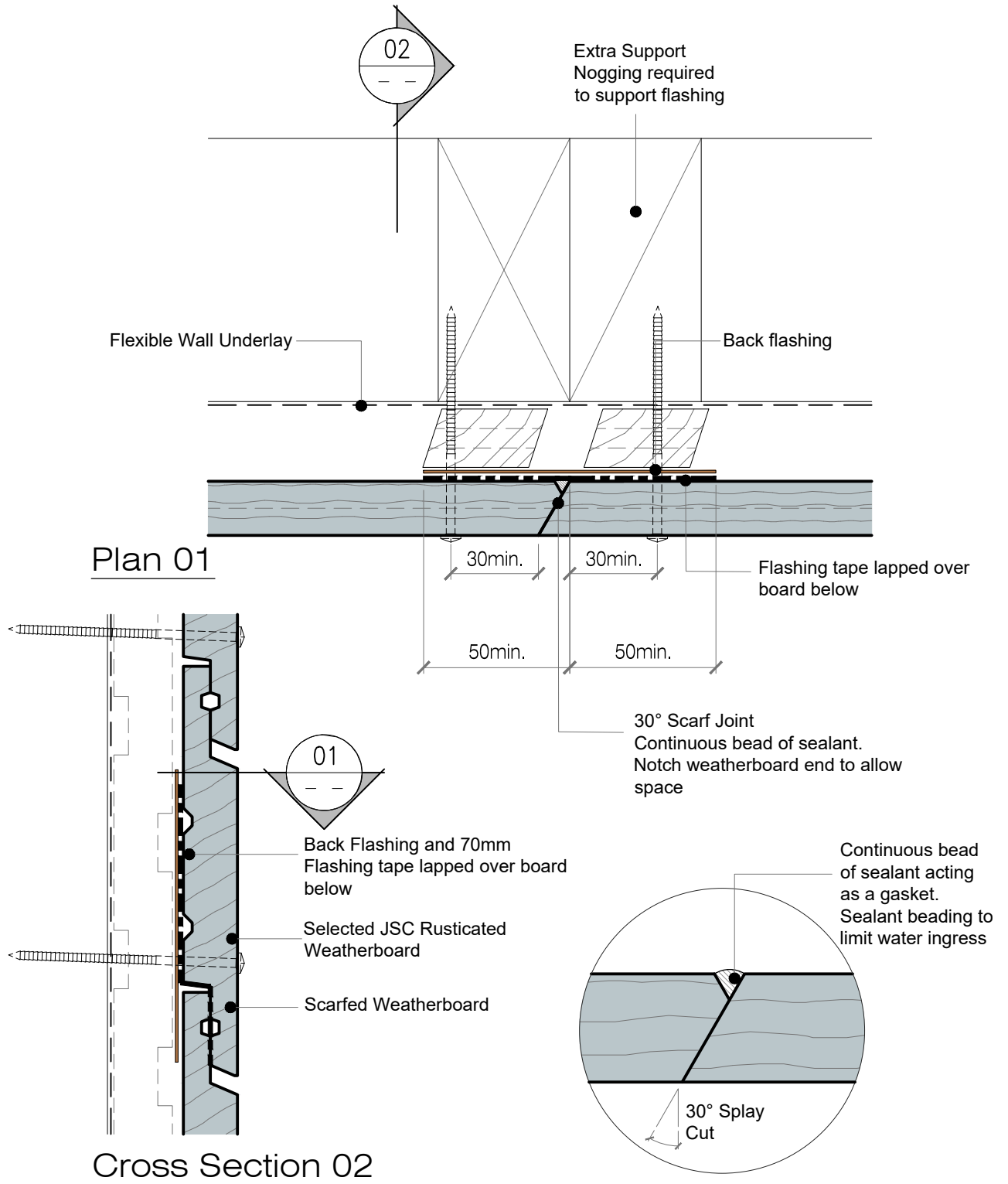

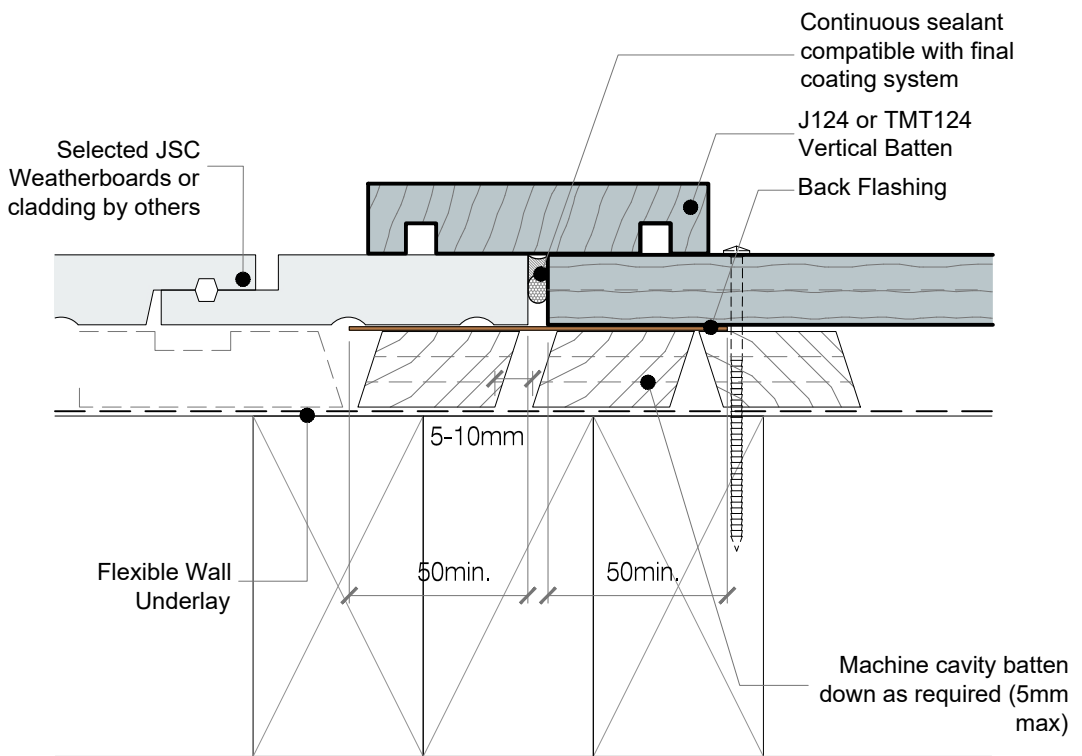

DRAWING SCALE 1:2 @ A4	ISSUE DATE 11/02/2026
DRAWING NUMBER JSC 20CF RC41	VERSION 2.6

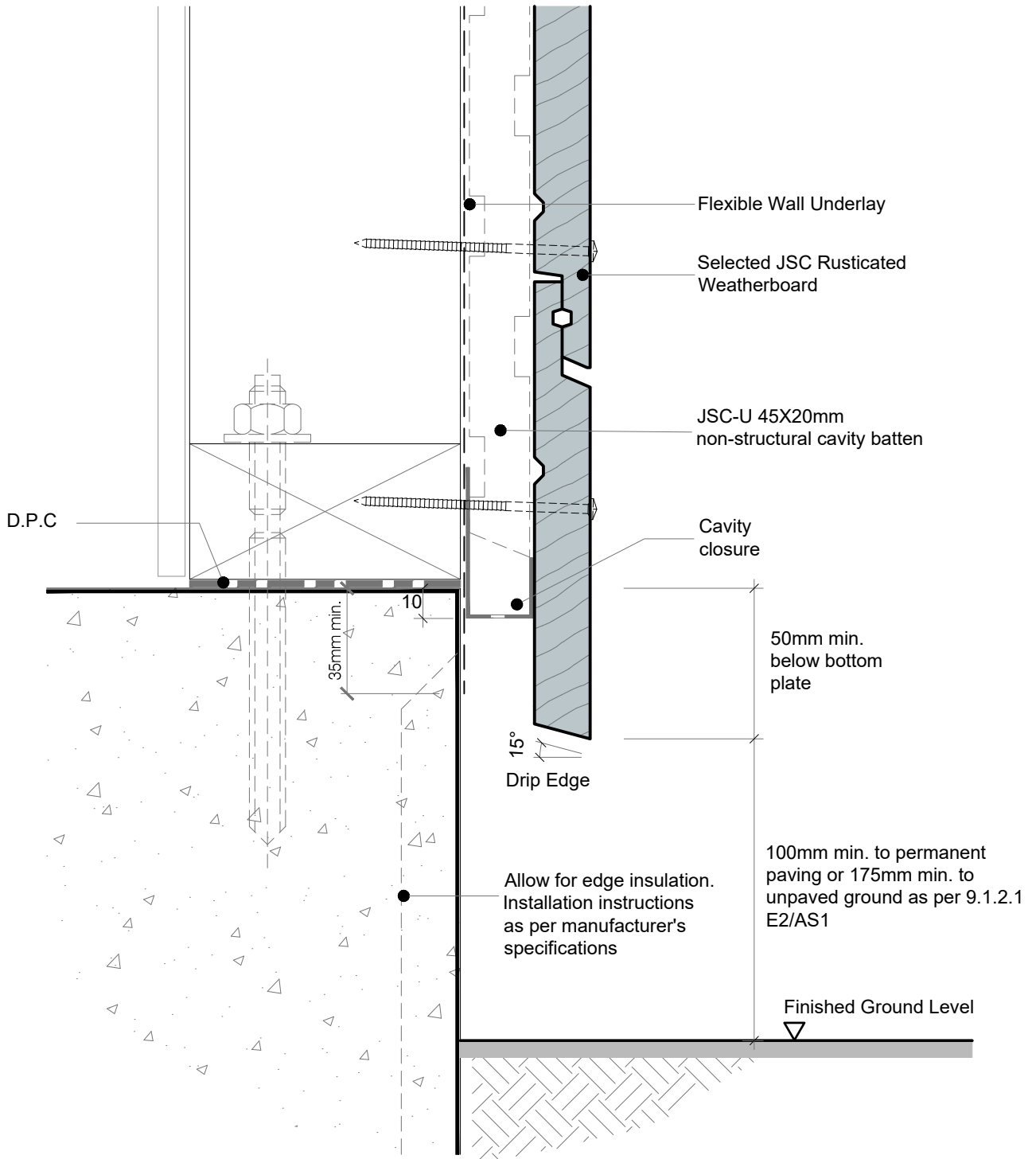

NOTE:

Bottom Board Fixing:

- Ensure that at least half the width of the board is supported by cavity battens.
- Nail to be placed close to the middle of the board as possible.
- Cut off the lap of the bottom board. Alternatively, use a wider board and trim it to match the cover of the other boards.
- Refer to JSC Rusticlad Design Guide and JSC Rusticlad Installation Guide for more information.



DRAWING SCALE 1:2 @ A4	ISSUE DATE 11/02/2026
DRAWING NUMBER JSC 20CF RC42	VERSION 2.6

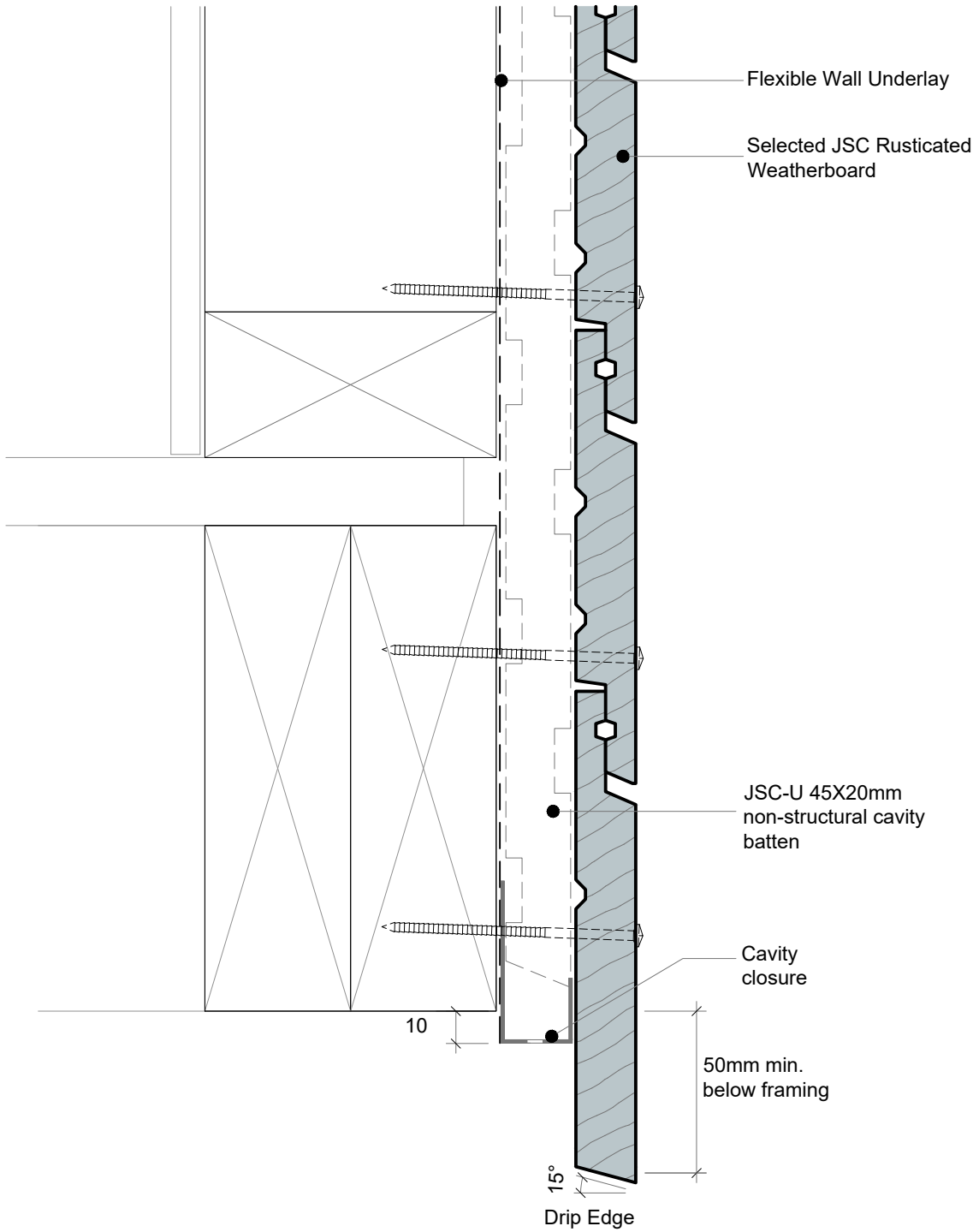

NOTE:

Bottom Board Fixing:

- Ensure that at least half the width of the board is supported by cavity battens.
- Nail to be placed close to the middle of the board as possible.
- Cut off the lap of the bottom board. Alternatively, use a wider board and trim it to match the cover of the other boards.
- Refer to JSC Rusticlad Design Guide and JSC Rusticlad Installation Guide for more information.



DRAWING SCALE 1:2 @ A4	ISSUE DATE 11/02/2026
DRAWING NUMBER JSC 20CF RC43	VERSION 2.6

-Refer to E2/AS1

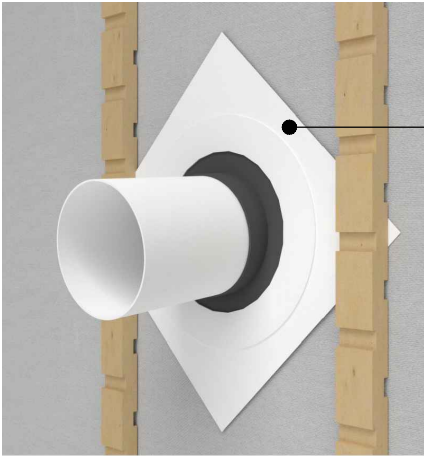

Proprietary self adhesive collar at 45°



Continuous weather seal around pipe



Sealant in the negative(s) around pipe penetration

Flange plate over pipe, sealed around pipe and top half of flange. Refer to Figure 9.1.8.3A E2/AS1

No sealant to drain

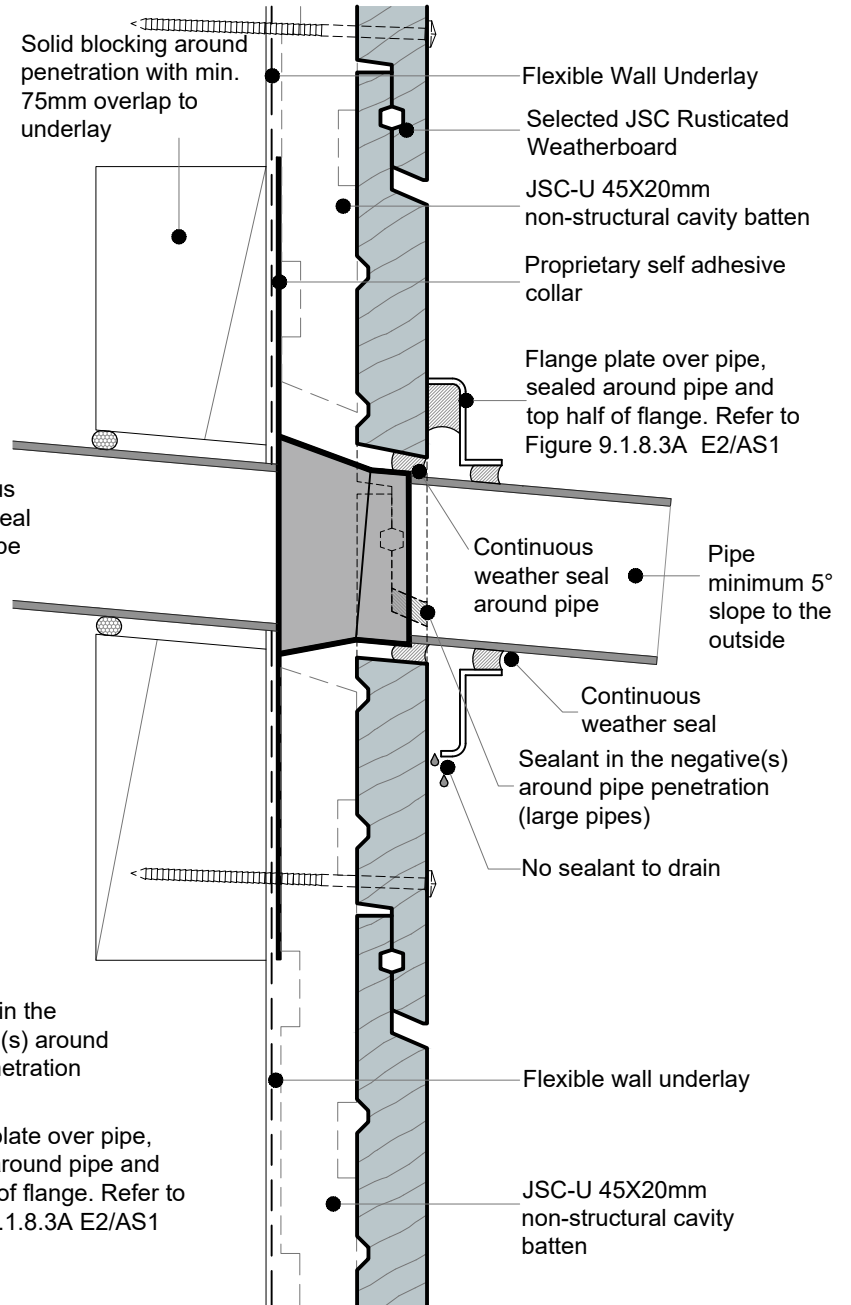

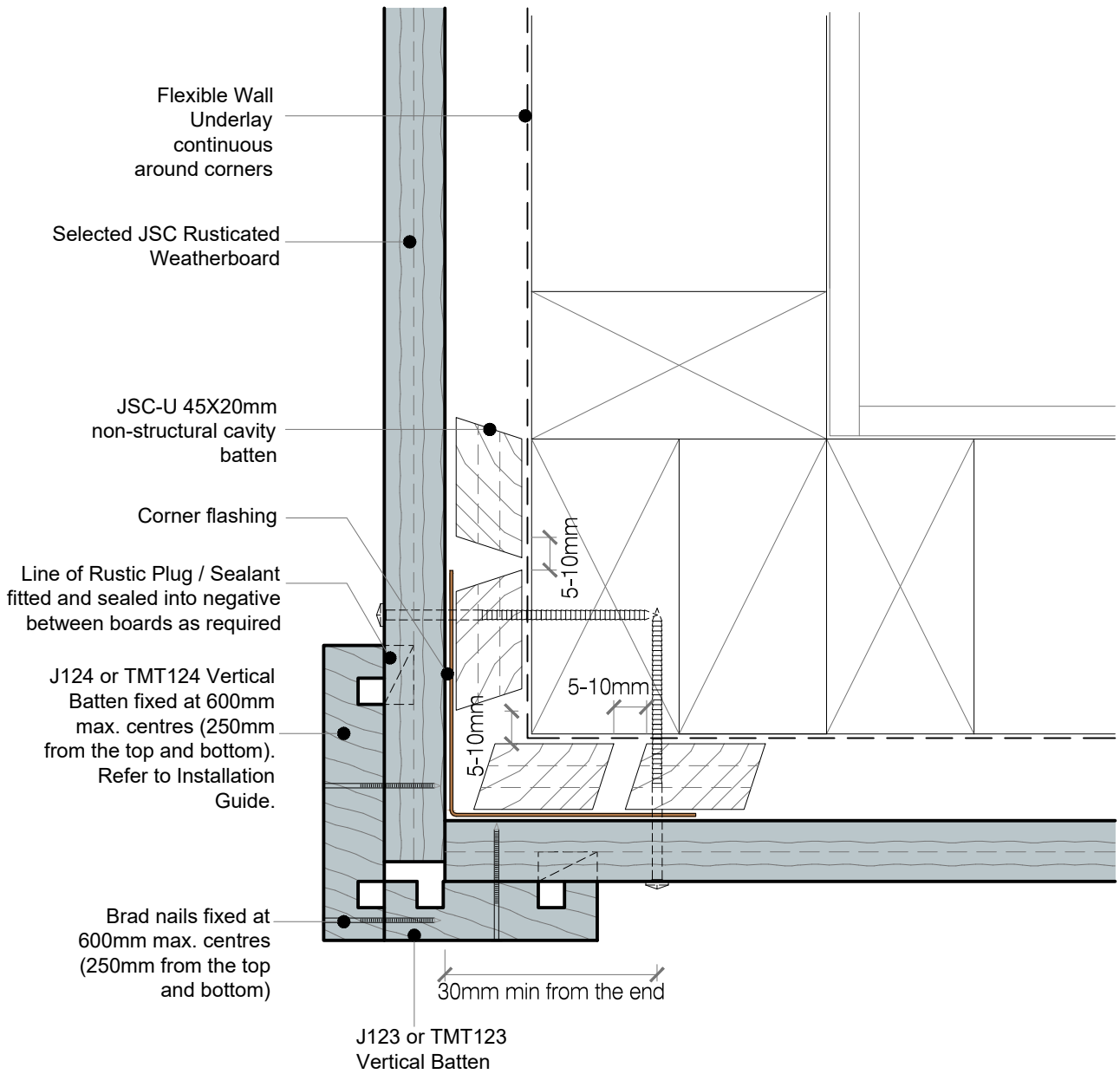

NOTES:

- Machine cavity battens down as required (5mm max) to accommodate corner flashing.
- Cut cavity battens on a 20-30° angle, sloping away from the framing.
- For Very High (VH) and Extra High (EH) wind zones, a solid batten (non-castellated) is required down one side of a significant external corner (change in elevation) to provide pressure isolation between elevations.
- JSC recommends this detail to be used for paint finished weatherboards.
- JSC recommends this detail to be used for Pine weatherboards.



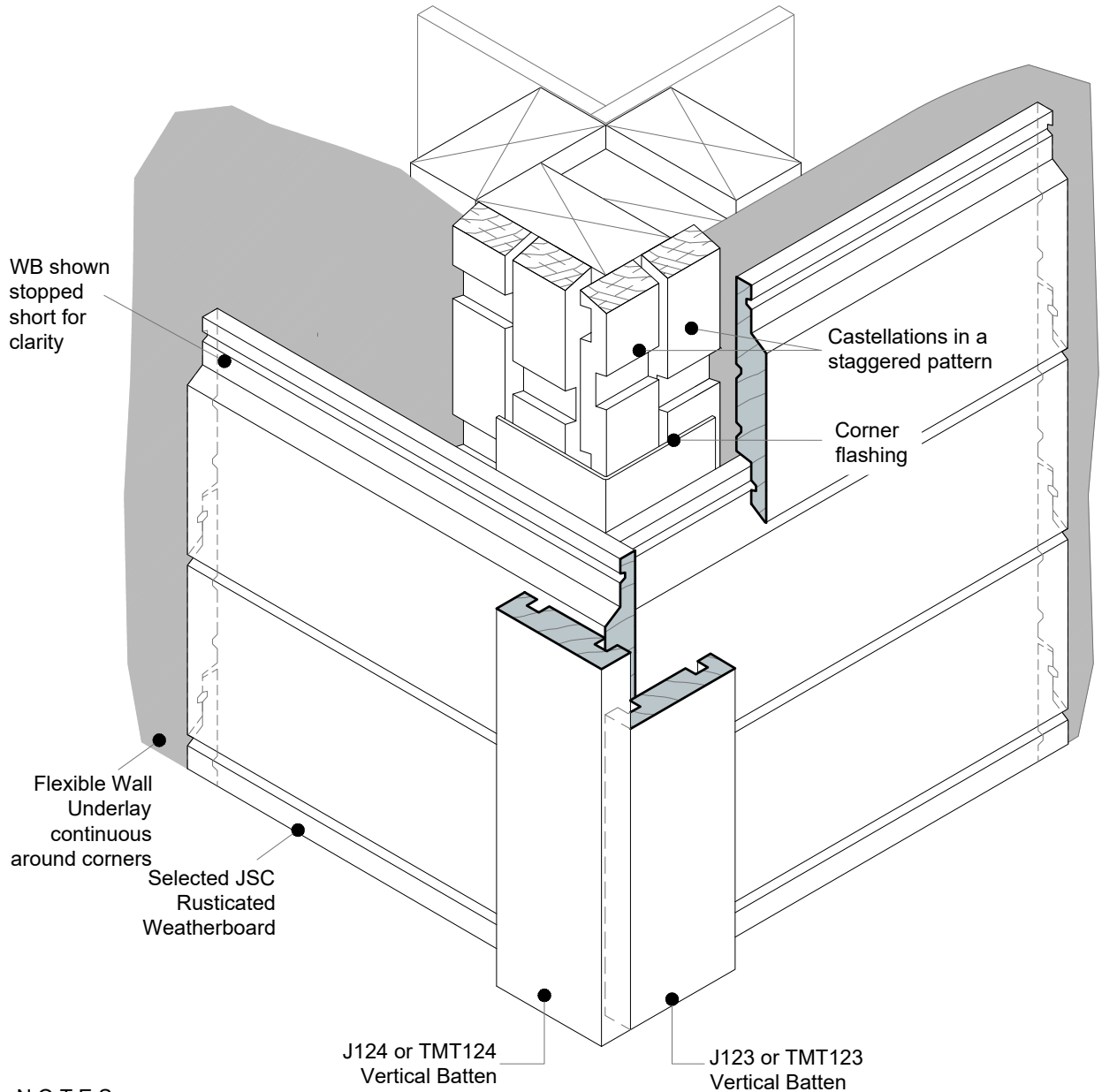

NOTES:

- Machine cavity batten down as required (5mm max) to accommodate corner flashing.
- Cut cavity battens on a 20-30° angle, sloping away from the framing.
- For Very High (VH) and Extra High (EH) wind zones, a solid batten (non-castellated) is required down one side of a significant external corner (change in elevation) to provide pressure isolation between elevations.
- JSC recommends this detail to be used for paint finished weatherboards.
- JSC recommends this detail to be used for Pine weatherboards.



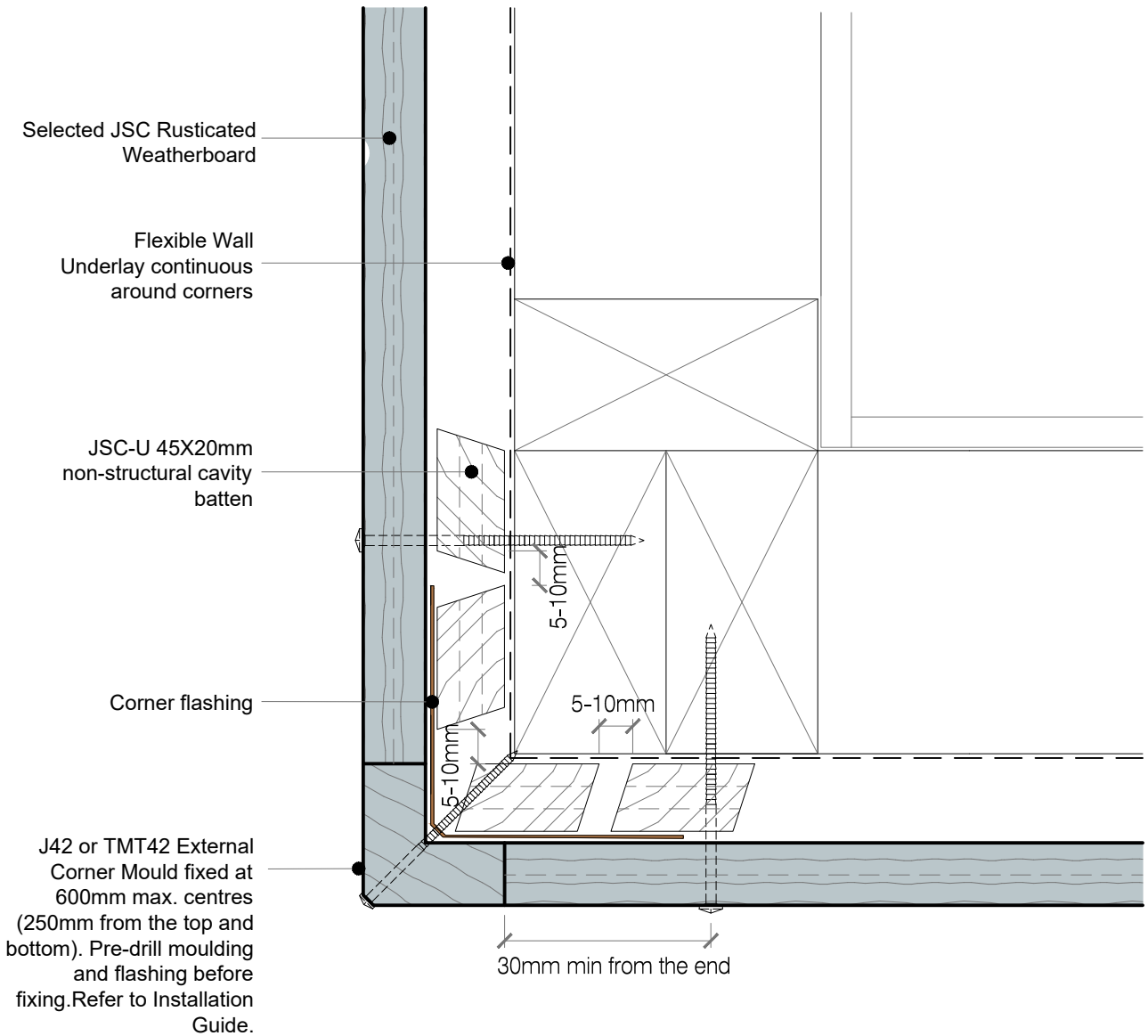

NOTES:

- Machine cavity battens down as required (5mm max) to accommodate corner flashing.
- Cut cavity battens on a 20-30° angle, sloping away from the framing.
- For Very High (VH) and Extra High (EH) wind zones, a solid batten (non-castellated) is required down one side of a significant external corner (change in elevation) to provide pressure isolation between elevations.
- JSC recommends this detail to be used for paint finished weatherboards.
- This detail is not recommended for Pine weatherboards.



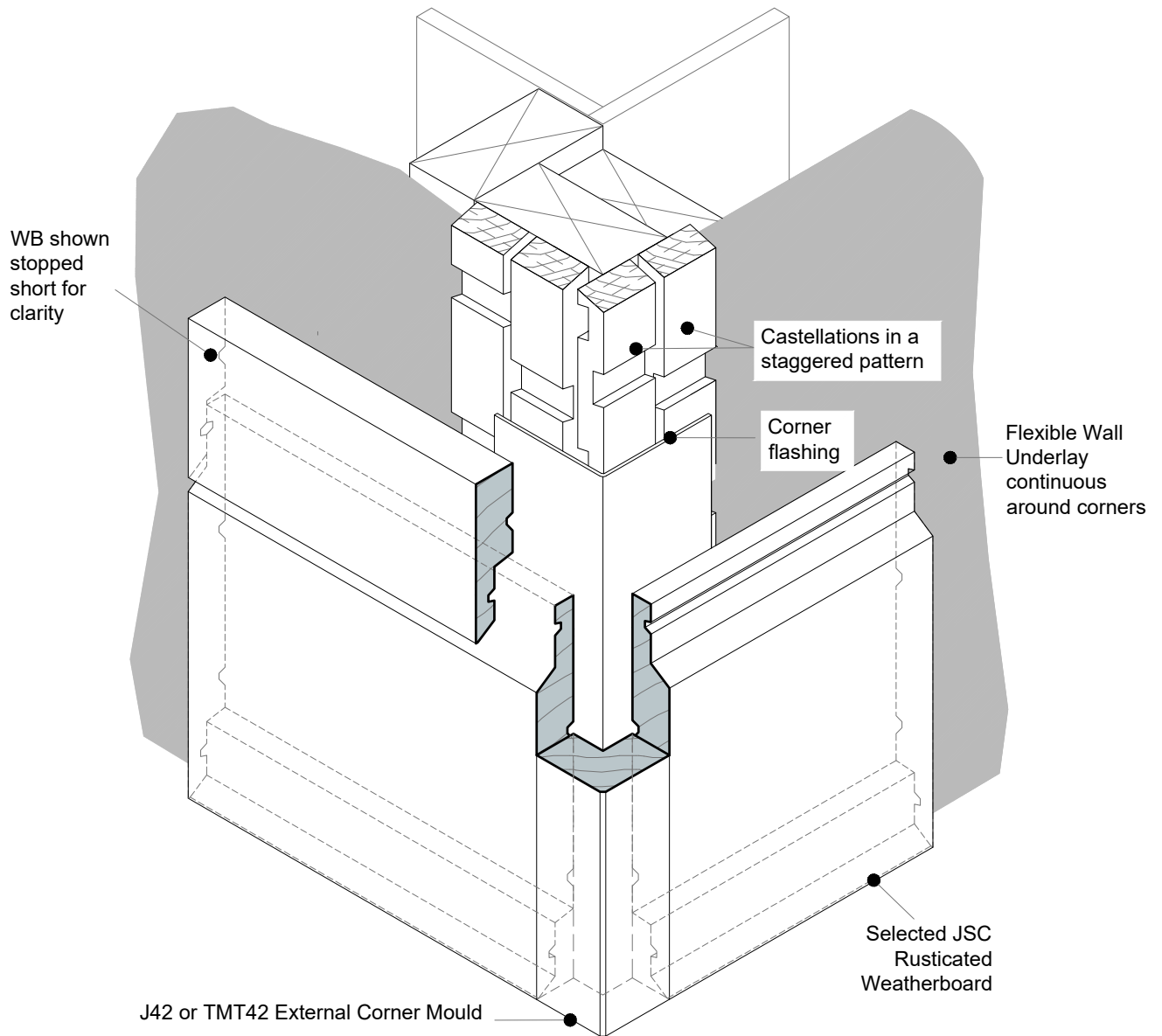

NOTES:

- Machine cavity battens down as required (5mm max) to accommodate corner flashing.
- Cut cavity battens on a 20-30° angle, sloping away from the framing.
- For Very High (VH) and Extra High (EH) wind zones, a solid batten (non-castellated) is required down one side of a significant external corner (change in elevation) to provide pressure isolation between elevations.
- JSC recommends this detail to be used for paint finished weatherboards.
- This detail is not recommended for Pine weatherboards.



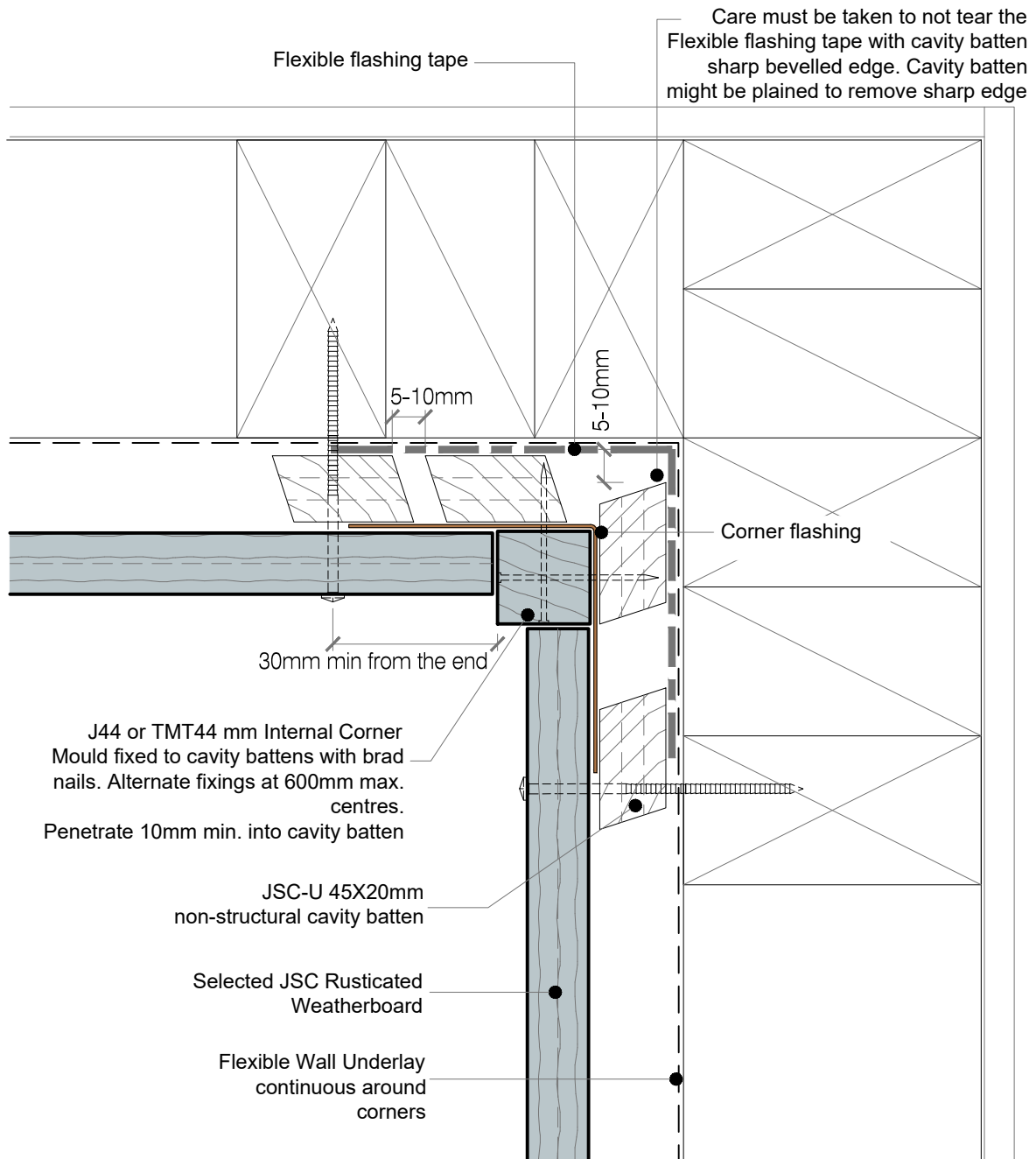

NOTES:

- Machine cavity battens down as required (5mm max) to accommodate corner flashing.
- Cut horizontal and vertical cavity battens on a 20-30° angle, sloping away from the framing.
- Flexible flashing tape is recommended due to movement that may occur in corners but it is not required by E2/AS1.



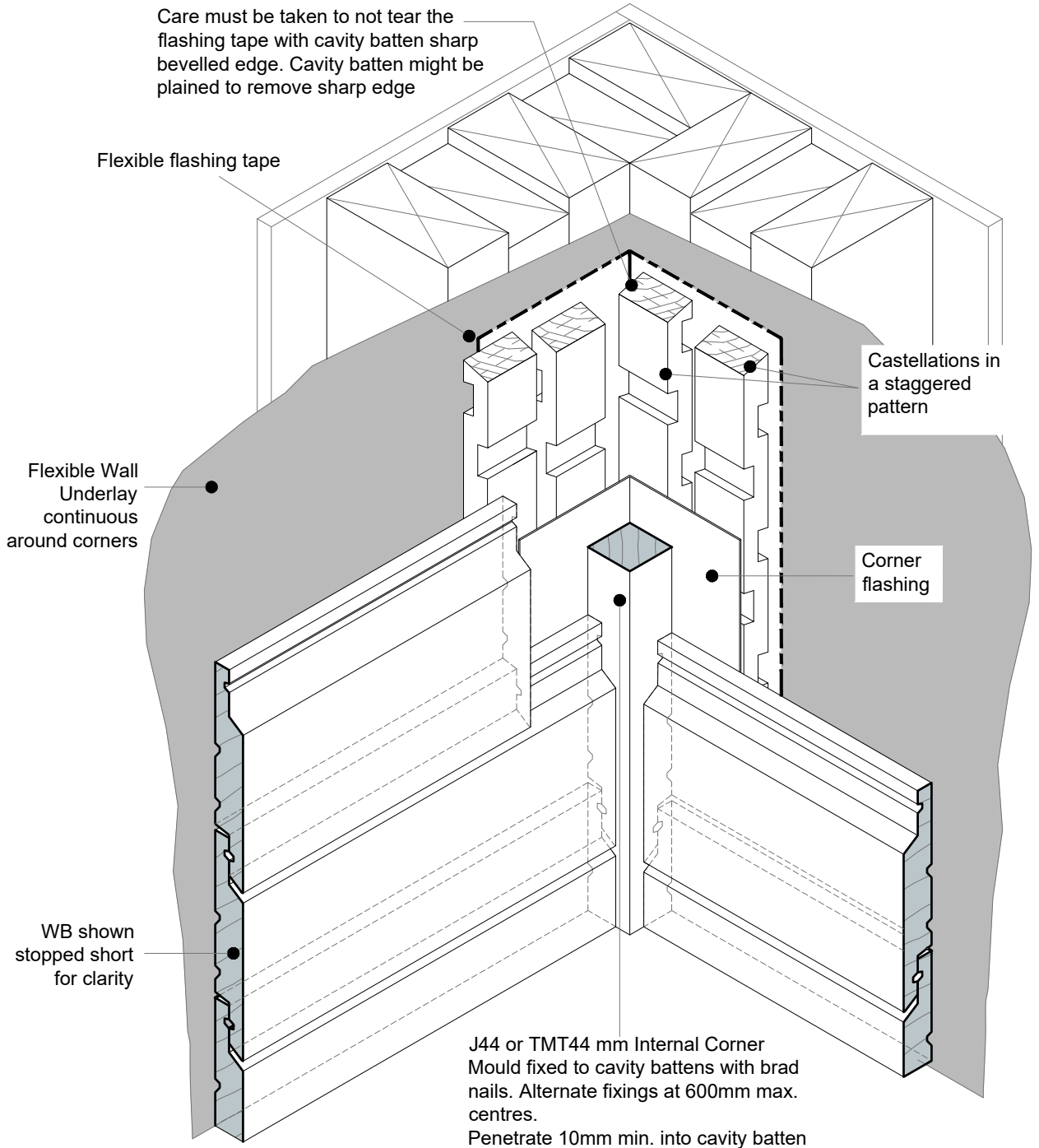

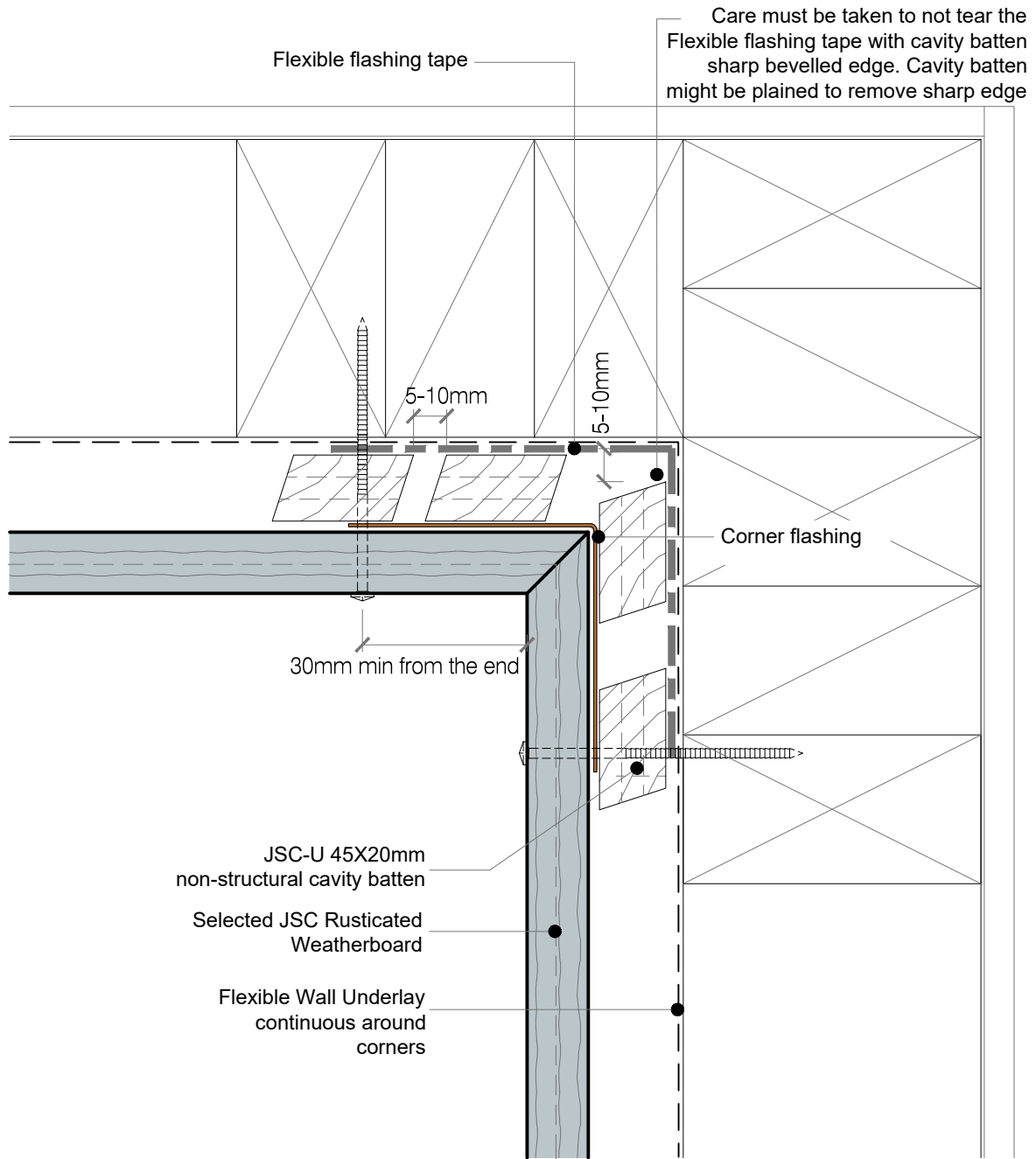

NOTES:

- Machine cavity battens down as required (5mm max) to accommodate corner flashing.
- Cut horizontal and vertical cavity battens on a 20-30° angle, sloping away from the framing.
- Flexible flashing tape is recommended due to movement that may occur in corners but it is not required by E2/AS1.



DRAWING SCALE 1:2 @ A4	ISSUE DATE 11/02/2026
DRAWING NUMBER JSC 20CF RC62	VERSION 2.6

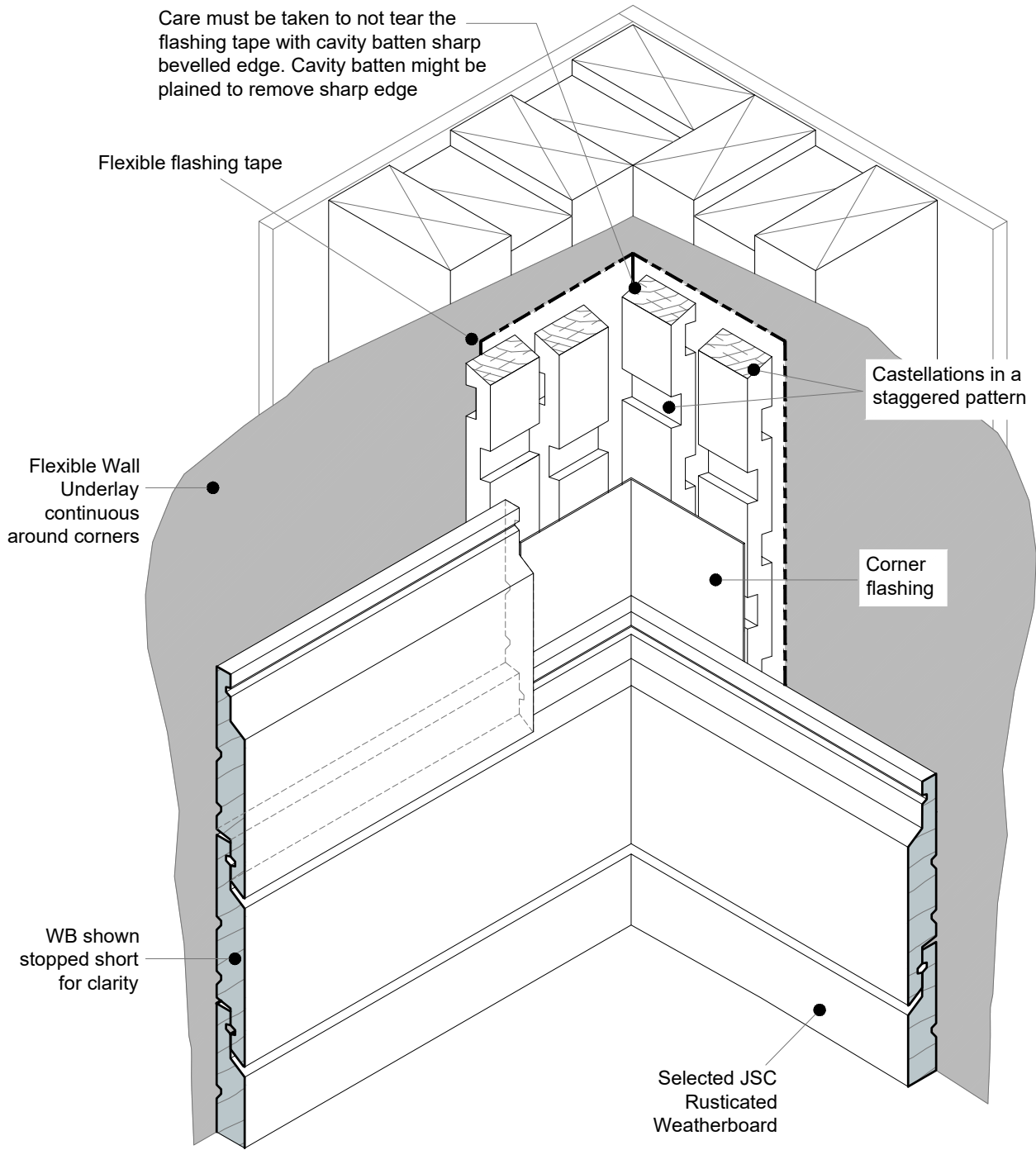

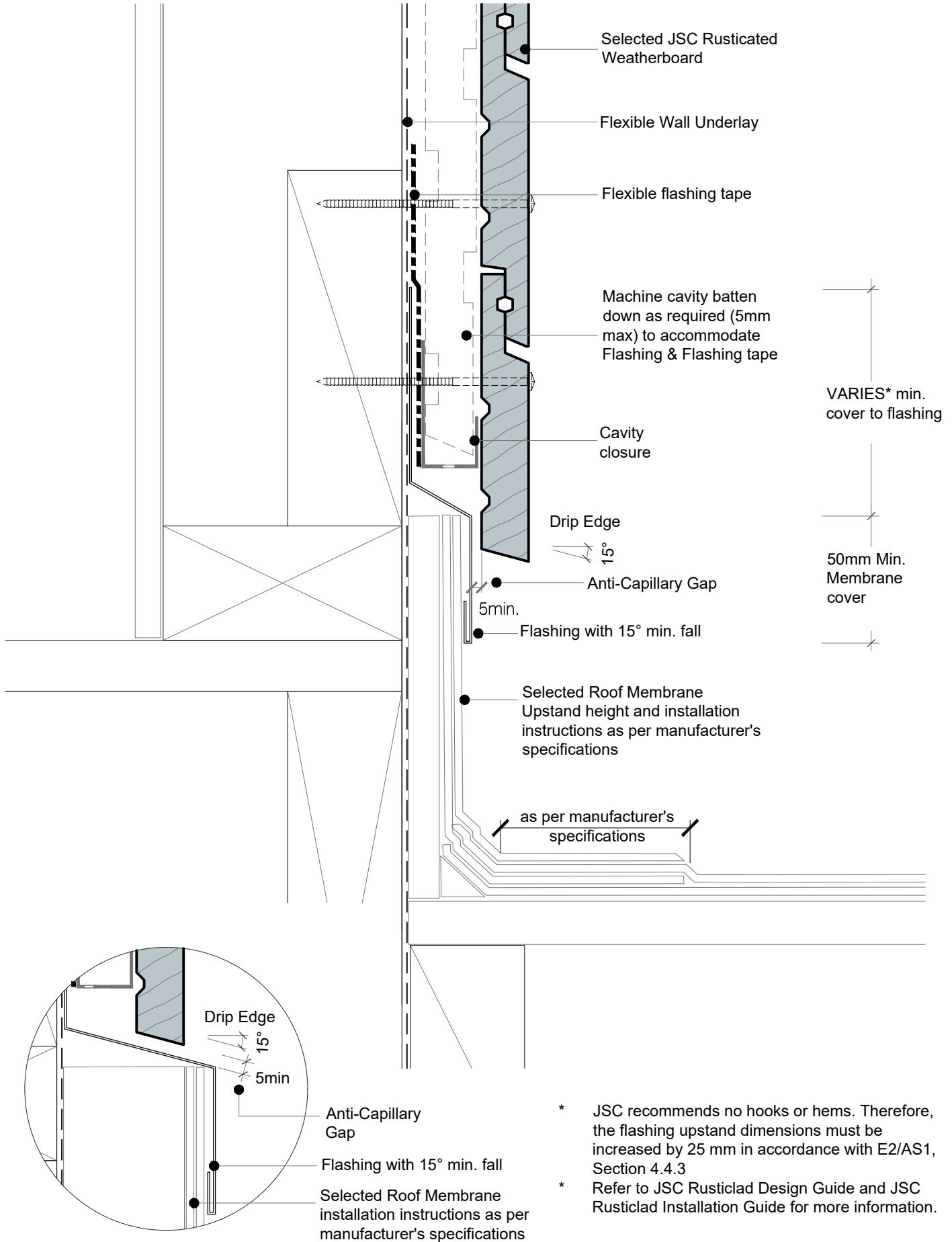

- * JSC recommends no hooks or hems. Therefore, the flashing upstand dimensions must be increased by 25 mm in accordance with E2/AS1, Section 4.4.3
- * Refer to JSC Rusticlad Design Guide and JSC Rusticlad Installation Guide for more information.

CodeMark
CMNZ30081



DRAWING SCALE NTS	ISSUE DATE 11/02/2026
DRAWING NUMBER JSC 20CF RC70	VERSION 2.6

SEQUENCE :

1. Framing
2. Wall Underlay
3. Parapet Cavity battens
4. Packer to form slope
5. Flexible Flashing tape

DETAIL NOTE :

REFER TO E2/AS1 Figure 6.2.3.1B FOR SADDLE FLASHING DIMENSIONS

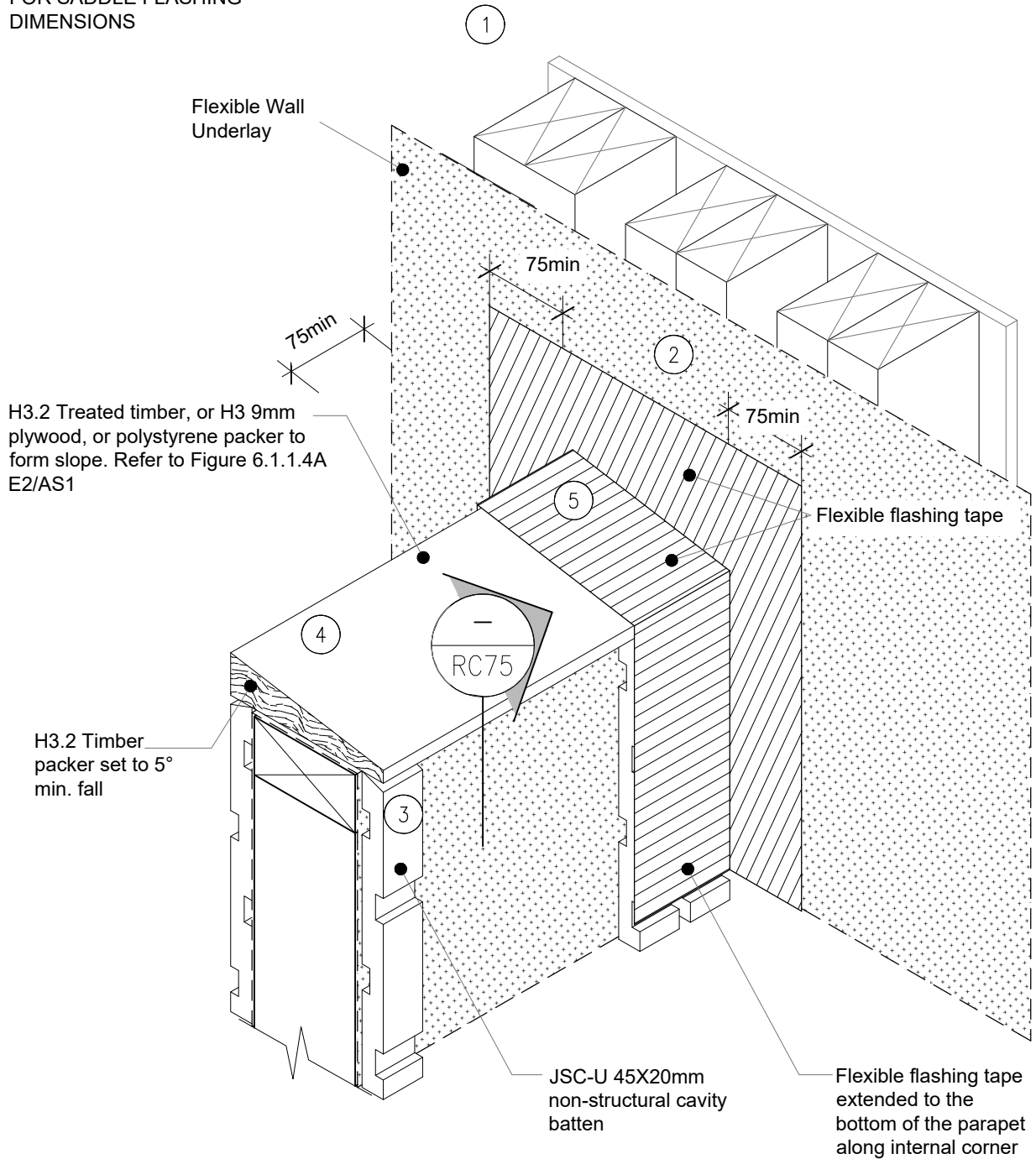

DRAWING SCALE NTS	ISSUE DATE 11/02/2026
DRAWING NUMBER JSC 20CF RC71a	VERSION 2.6

DETAIL NOTE :

REFER TO E2/AS1 Figure 6.2.3.1B FOR SADDLE FLASHING DIMENSIONS

1. Framing
2. Wall Underlay
3. Parapet Cavity battens
4. Packer to form slope
5. Flexible Flashing tape
6. Cavity battens on wall
7. Corner flashings

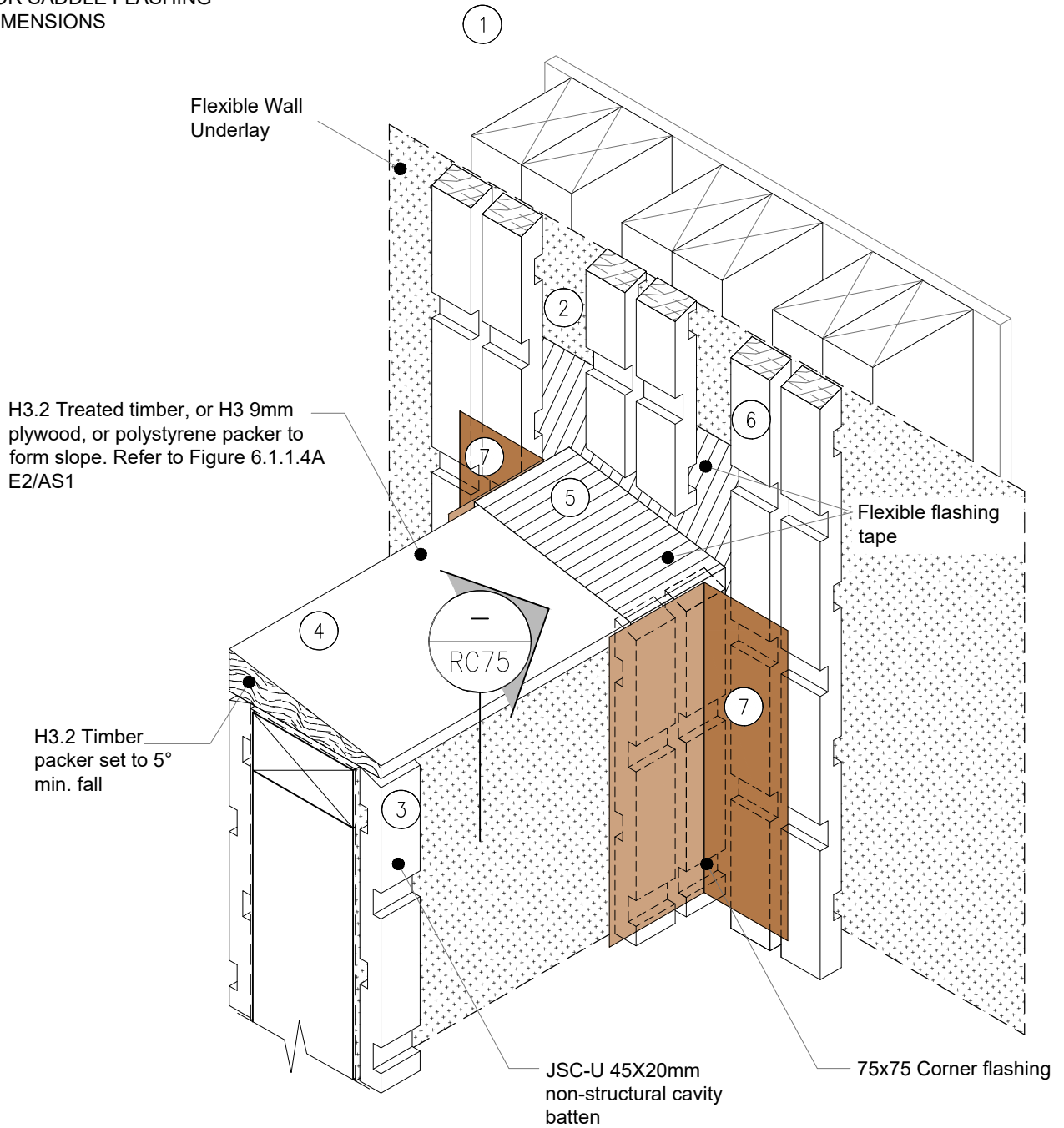

DRAWING SCALE NTS	ISSUE DATE 11/02/2026
DRAWING NUMBER JSC 20CF RC71b	VERSION 2.6

DETAIL NOTE :

REFER TO E2/AS1 Figure 6.2.3.1B
FOR SADDLE FLASHING
DIMENSIONS

SEQUENCE :

- 8. Cladding on Parapet
- 9. Separation layer
- 10. Saddle Flashing

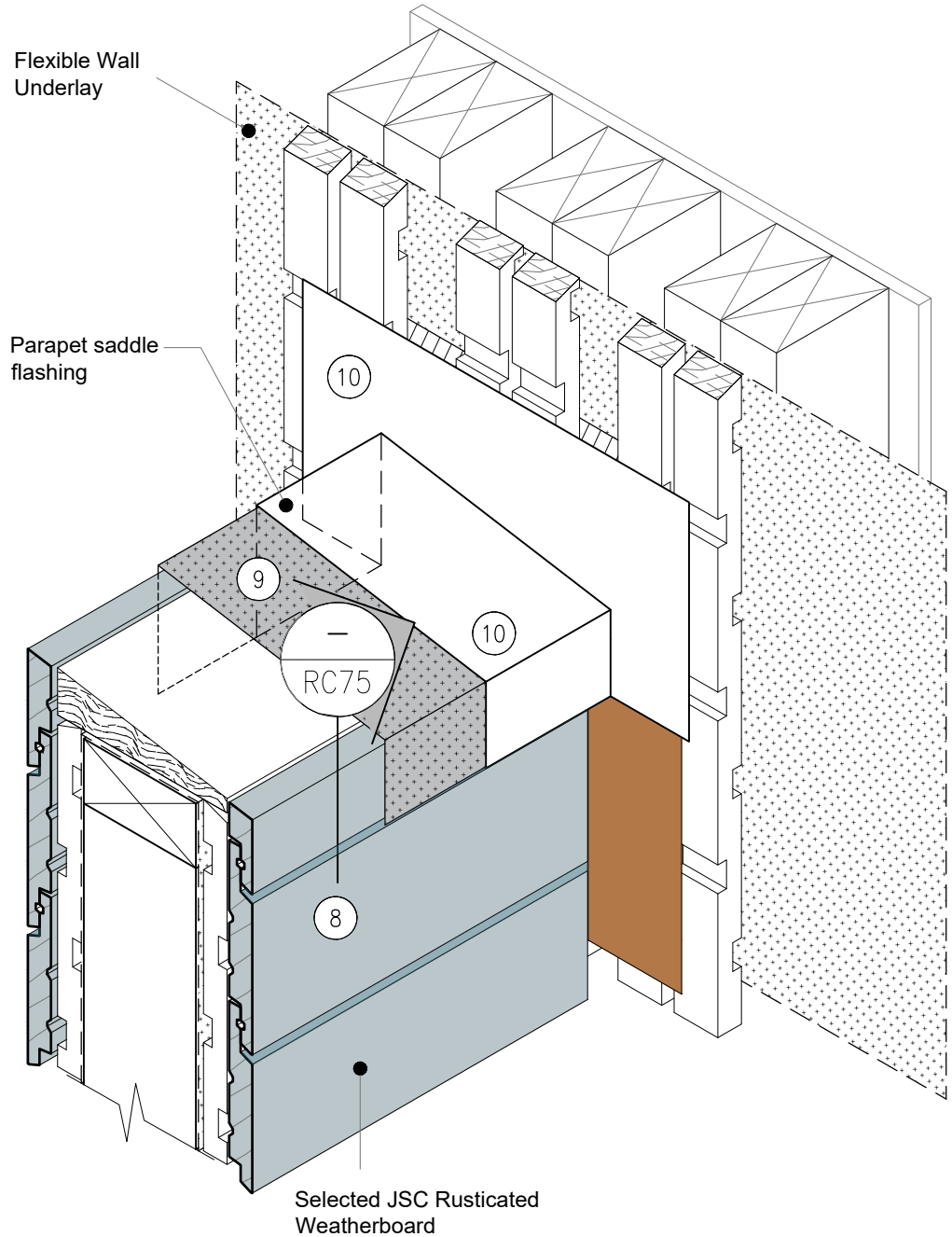

DRAWING SCALE NTS	ISSUE DATE 11/02/2026
DRAWING NUMBER JSC 20CF RC71c	VERSION 2.6

DETAIL NOTE :

REFER TO E2/AS1 Figure 6.2.3.1B
FOR SADDLE FLASHING
DIMENSIONS
AND FOR CAP FLASHING FIXINGS

SEQUENCE :

- 11. Cladding over saddle flashing
- 12. Cap flashing

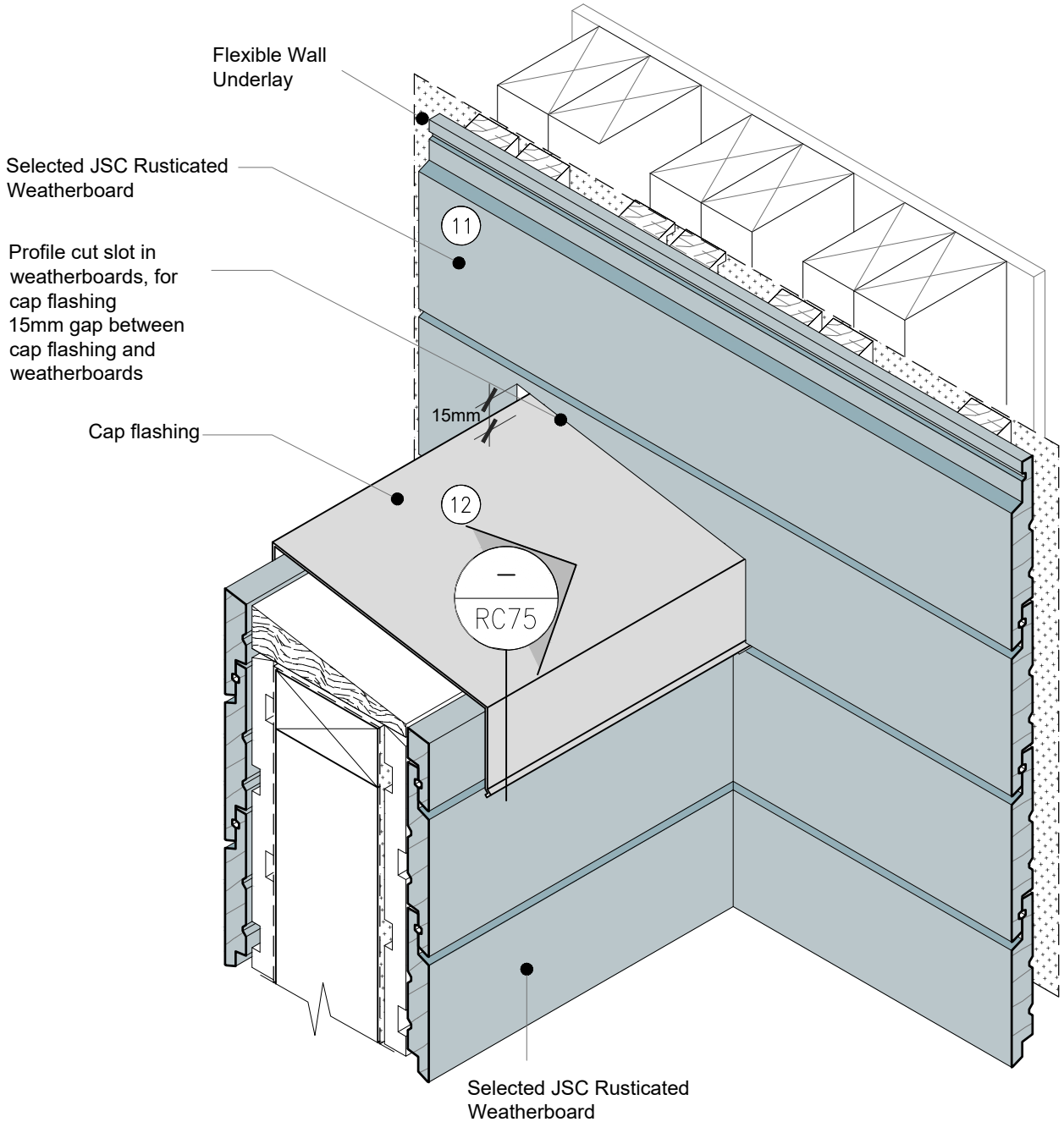

DRAWING SCALE 1:2 @ A4	ISSUE DATE 11/02/2026
DRAWING NUMBER JSC 20CF RC71d	VERSION 2.6

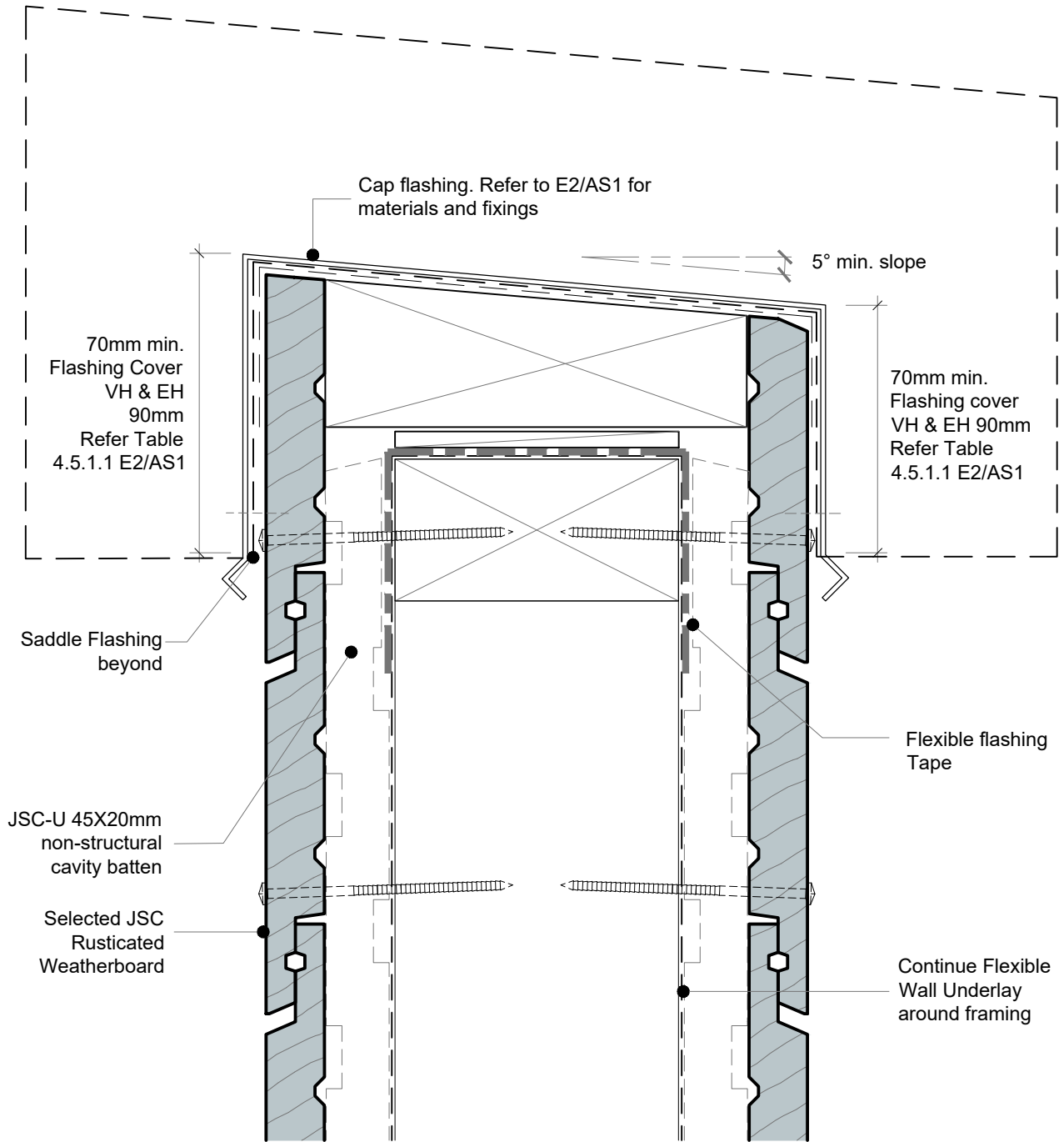

DRAWING SCALE 1:2 @ A4	ISSUE DATE 11/02/2026
DRAWING NUMBER JSC 20CF RC75	VERSION 2.6

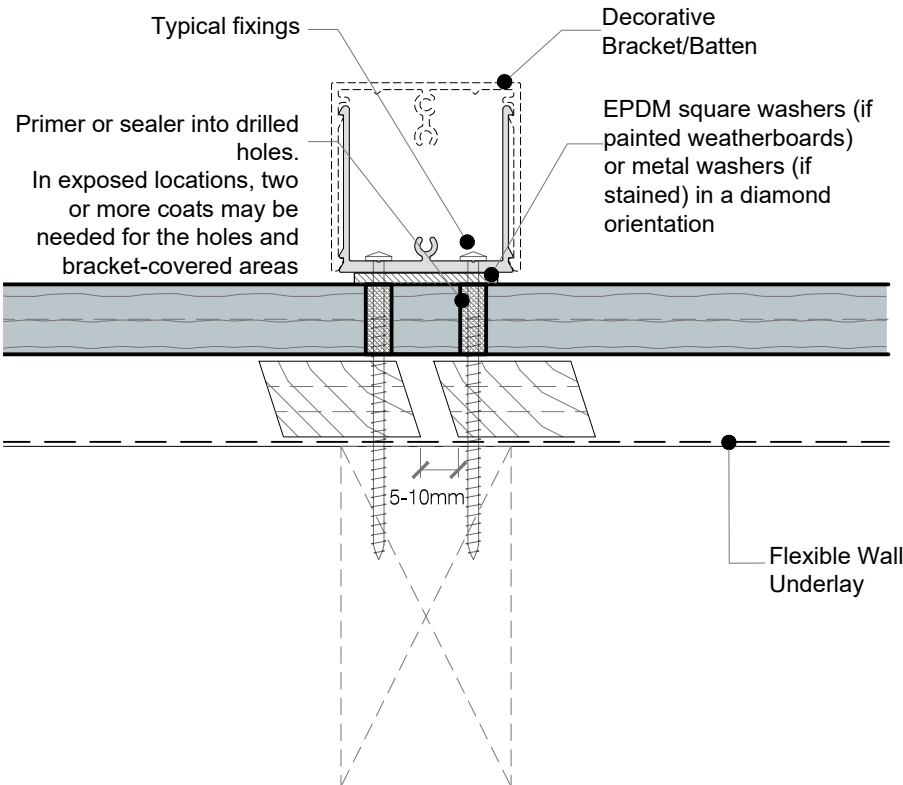
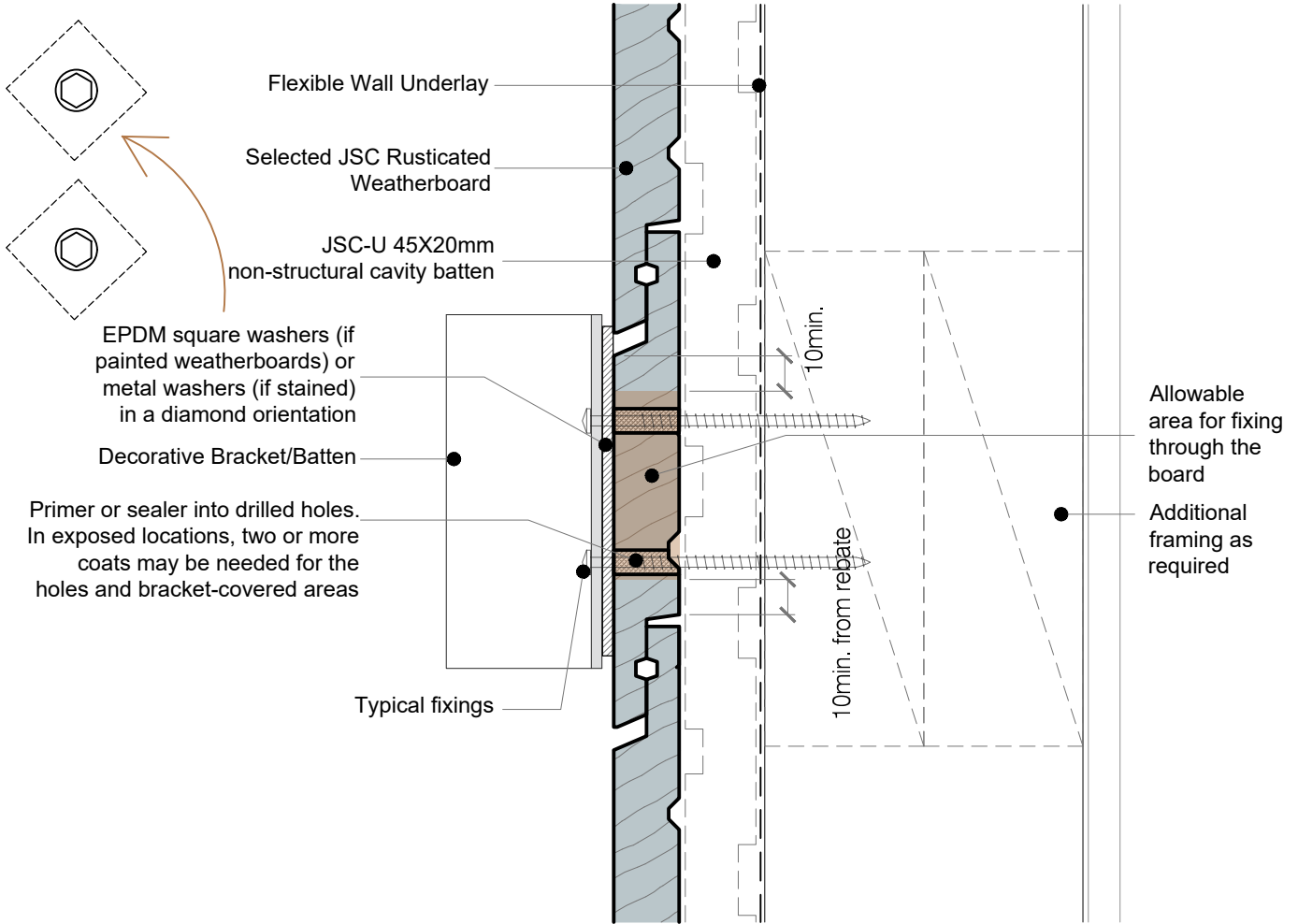

NOTES:

- This detail is to show penetration through the cladding. Framing structure and fixings as per NZS3604:2011 or Specific engineered design.
- Refer to this detail as a principle rather than specific instruction.
- Durable and compatible materials as specified in E2/AS1 Tables C.1.1.1C and C.2.1.1.
- If bracket fixings interfere with weatherboard laps, consider an alternative, such as an offset bracket.
- Fixings should be sufficient for the load, with this detail intended for low to medium forces (decorative batten)

Any penetration or contact with the cladding should:

- Be coated for water resistance (e.g., two coats of stain).
- Be inspectable; avoid hidden high-risk penetrations.
- Be maintainable; brackets should be removable for inspection or treatment of weatherboards.

CodeMark
CMNZ30081



DRAWING SCALE 1:2 @ A4	ISSUE DATE 11/02/2026
DRAWING NUMBER JSC 20CF RC77	VERSION 2.6

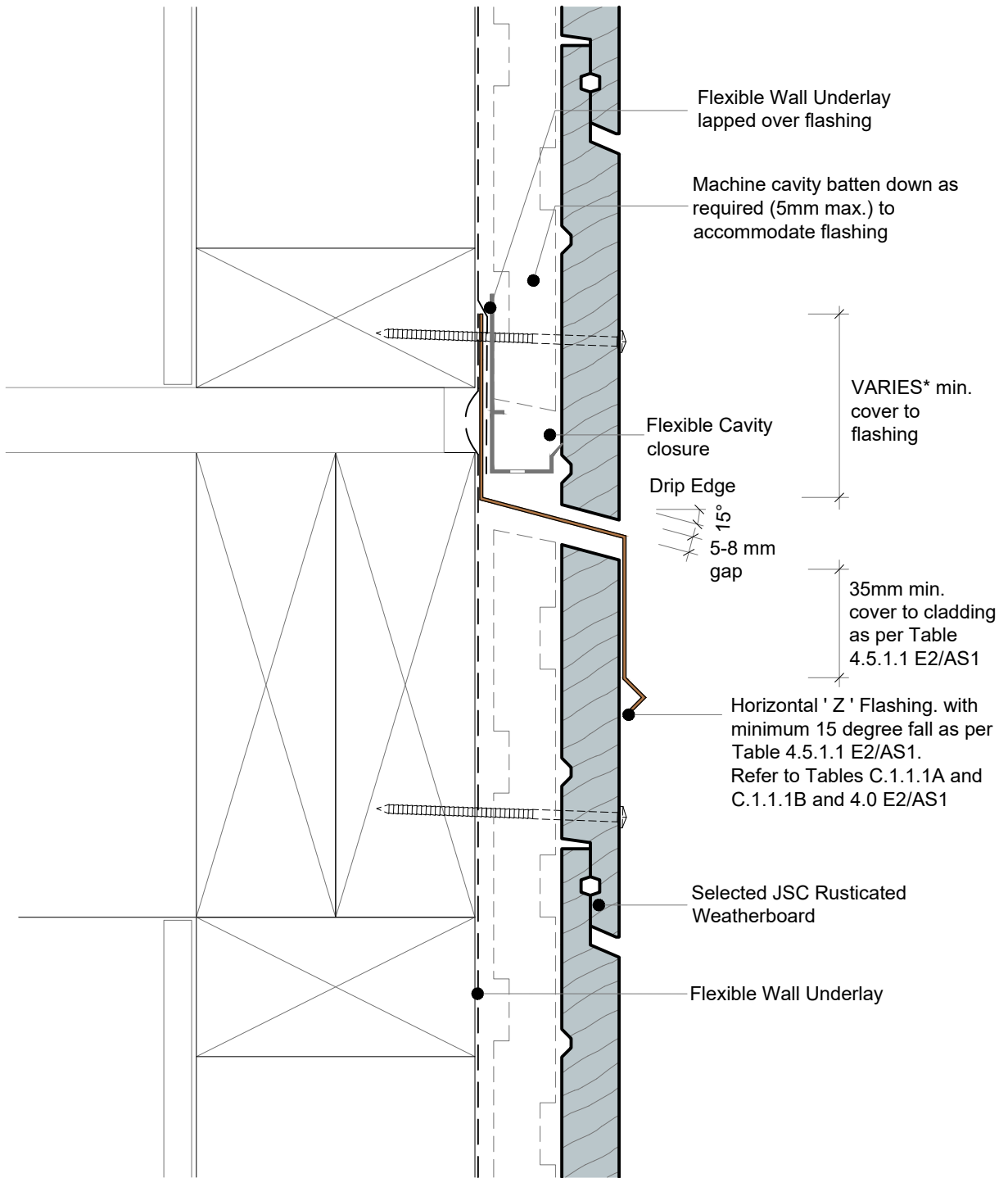

*JSC recommends no hooks or hems. Therefore, the flashing upstand dimensions must be increased by 25 mm in accordance with E2/AS1, Section 4.4.3



DRAWING SCALE 1:2 @ A4	ISSUE DATE 11/02/2026
DRAWING NUMBER JSC 20CF RC80	VERSION 2.6

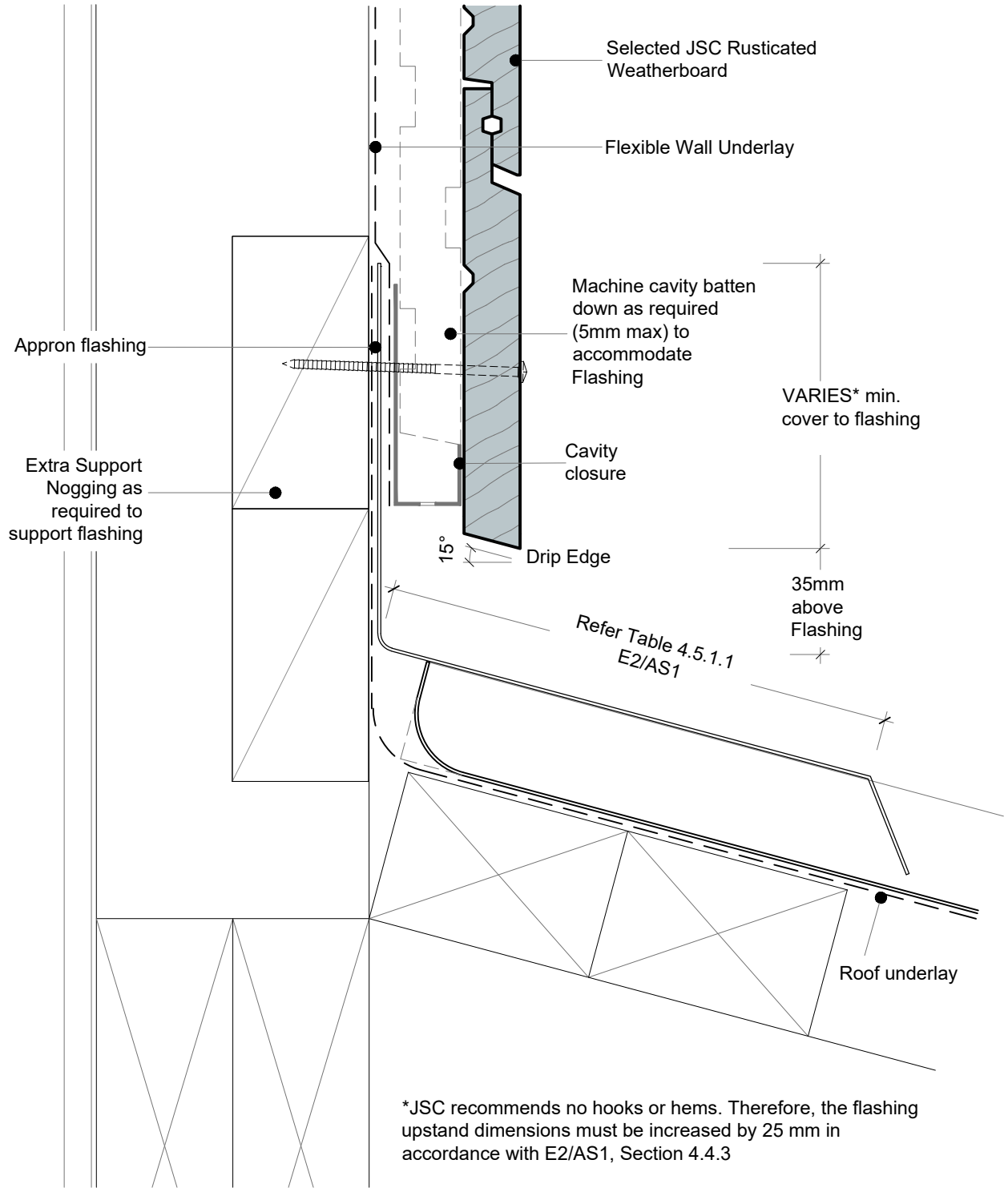

DRAWING SCALE 1:2 @ A4	ISSUE DATE 11/02/2026
DRAWING NUMBER JSC 20CF RC81	VERSION 2.6

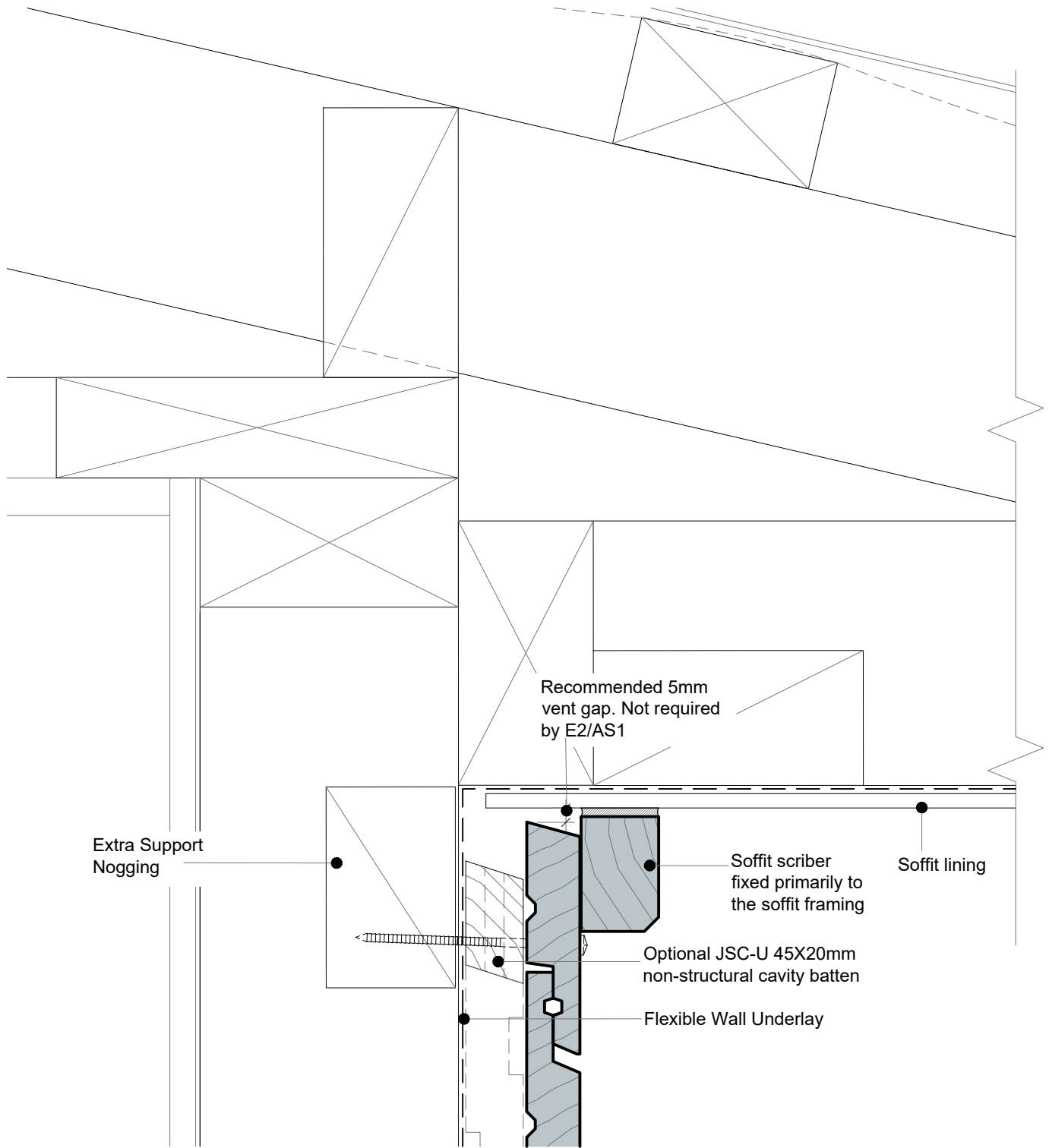

TYPE
RUSTICATED WB - 20MM CAVITY FIX

NAME
Soffit Detail at Wall

- TO BE READ IN CONJUNCTION WITH COMPLETE JSC RUSTICLAD SYSTEM LITERATURE
- DETAILS MAY BE SUBJECT CHANGE WITHOUT NOTICE



SCAN IT FOR MORE INFORMATION

DRAWING SCALE 1:2 @ A4
ISSUE DATE 11/02/2026

DRAWING NUMBER JSC 20CF RC82	VERSION 2.6
--	-----------------------

- Eave Flashing Required When
1. Roof Pitch 10° or less
 2. Soffit 100mm or less
 3. Wind Zone VH or EH

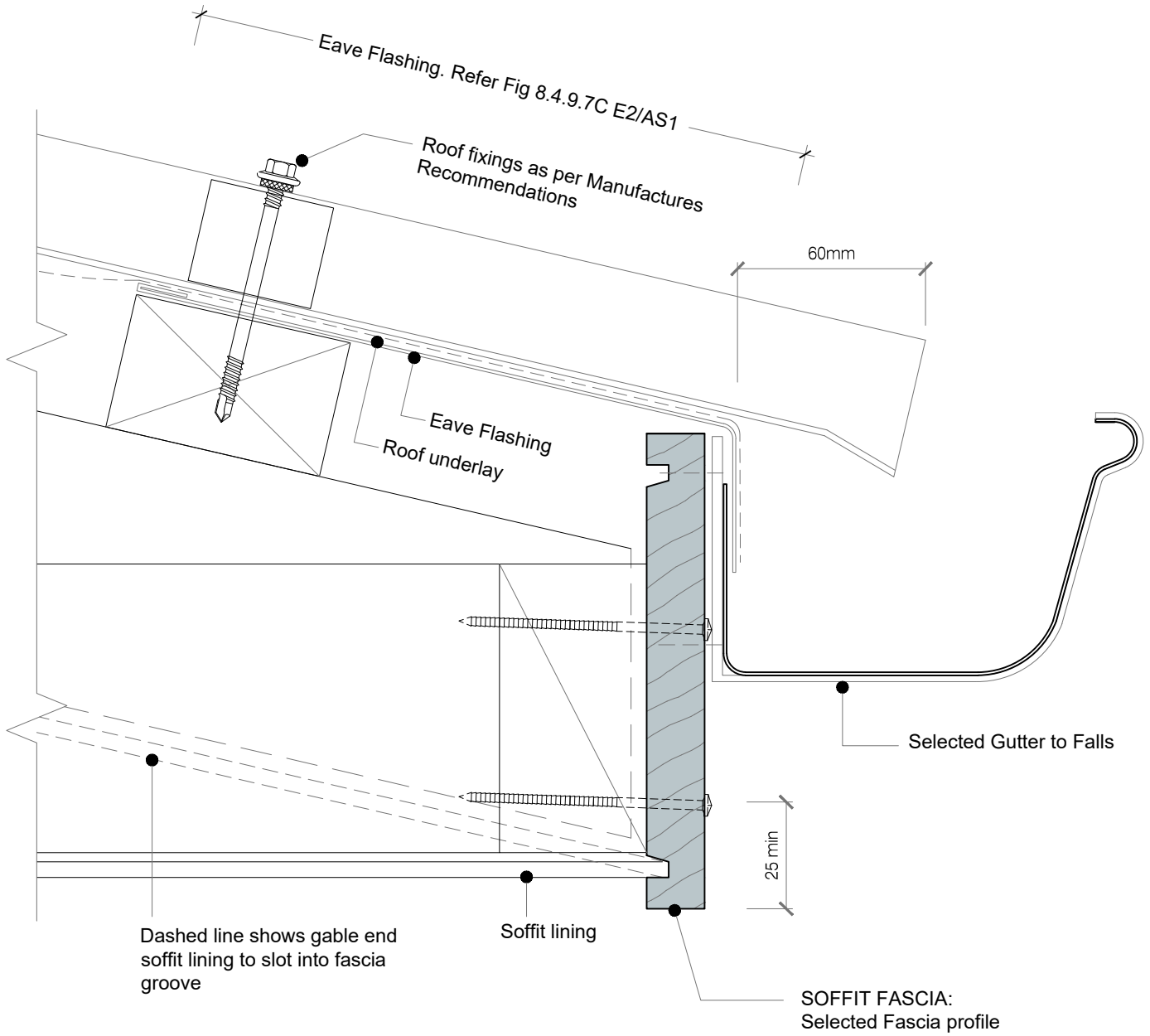

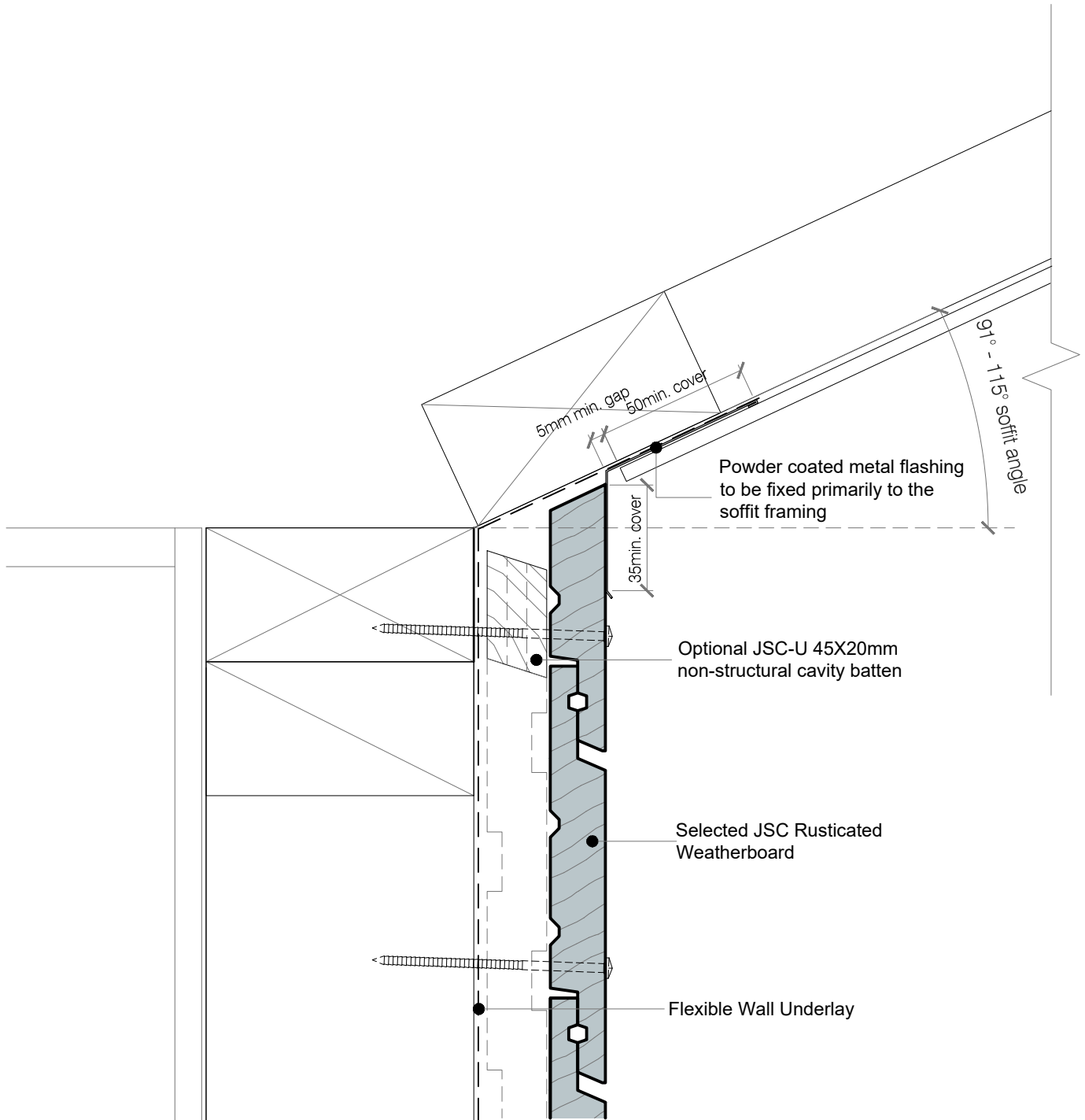

DRAWING SCALE 1:2 @ A4	ISSUE DATE 11/02/2026
DRAWING NUMBER JSC 20CF RC84	VERSION 2.6

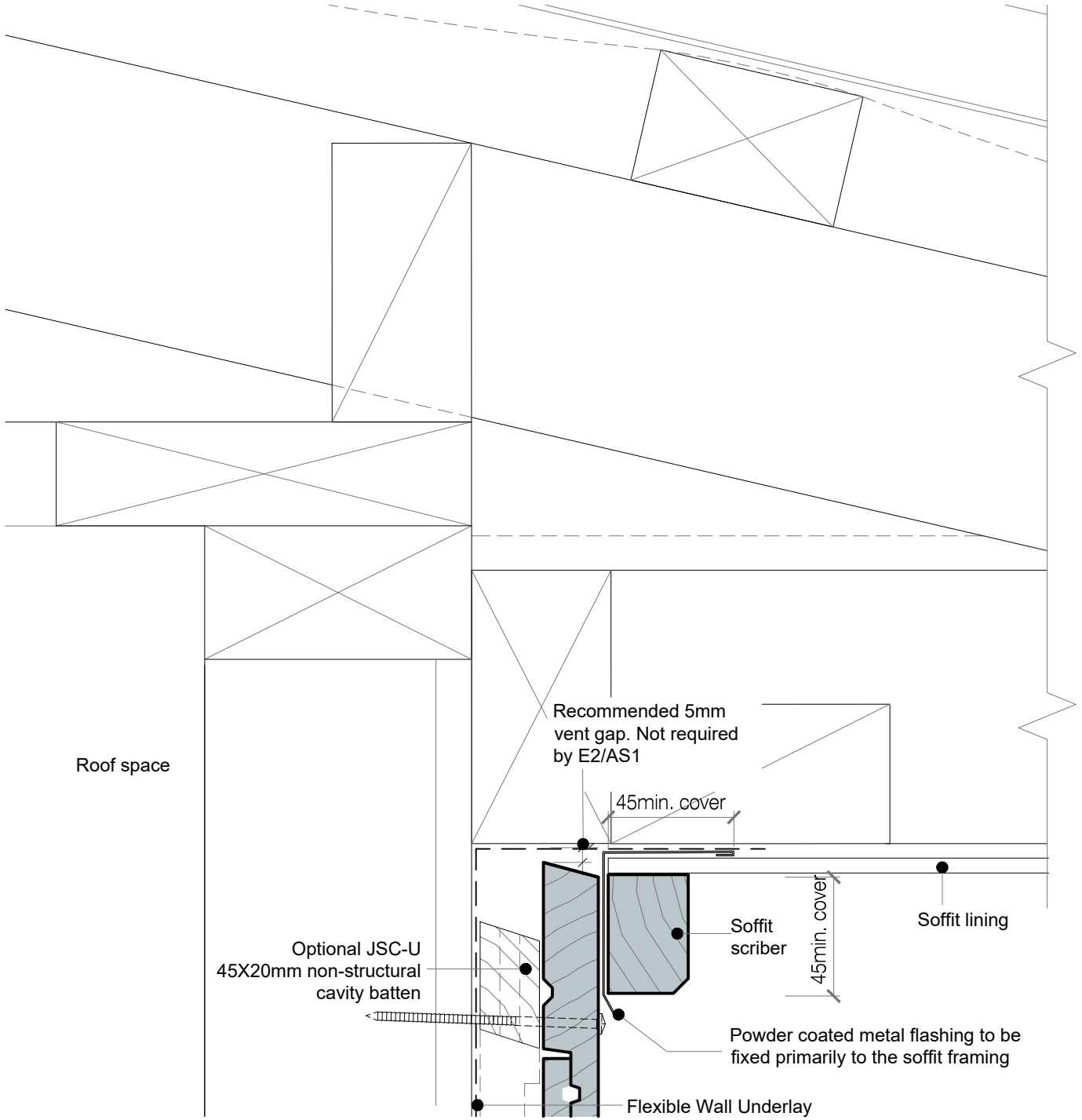

DETAIL NOTES :

1. 45° max. fall along soffit juncton
2. Refer to BRANZ Build 158-27 - Build Right Soffit Details at Gable Verge



Weatherboards:

- Single fix at each cavity batten with annular grooved nails (stainless steel 316 or silicon bronze) as per NZBC E2/AS1 Table C.3.1.1
- Pre-drill holes 0.5mm to 1mm smaller than the nail gauge. Example: For a 75mm nail, use a 2.5mm drill
- Nail with slight (0-2°) upward slope
- Fixings to achieve a minimum of 30mm penetration into the framing
- Fixings to be minimum 30mm from the ends of boards
- Nailed 10mm above the top of the lower board
- Do not rely on clinch nails for spacing

Cavity battens:

- Will be fixed by the cladding fixings, which will penetrate the wall framing. Battens only need temporary fixing until the cladding is fixed (E2/AS1 - Table C.3.1.1)
- Must always be installed sloping away from the framing
- Must have a 5-10mm gap between them

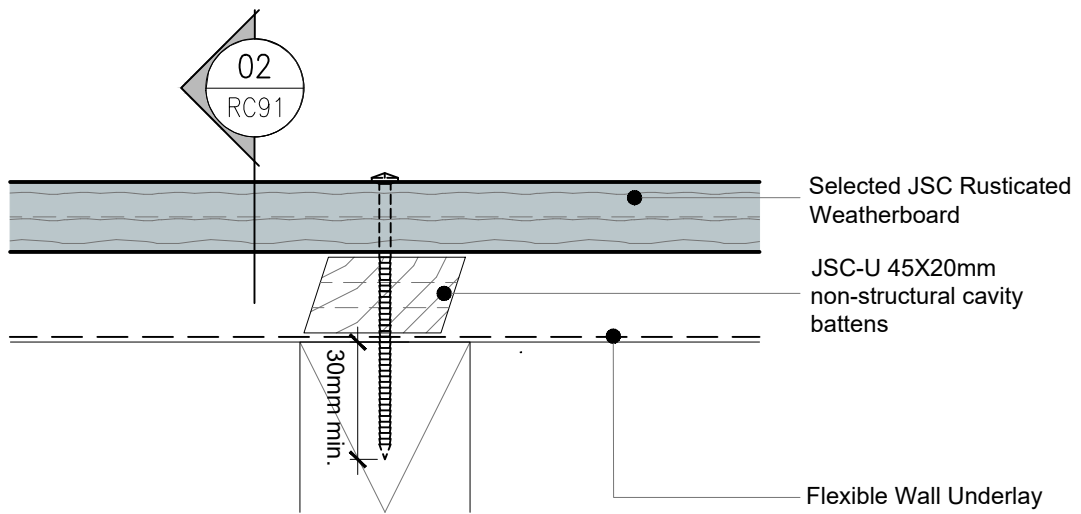

Plan



DRAWING SCALE 1:2 @ A4	ISSUE DATE 11/02/2026
DRAWING NUMBER JSC 20CF RC90	VERSION 2.6

Weatherboards:

- Single fix at each cavity batten with annular grooved nails (stainless steel 316 or silicon bronze) as per NZBC E2/AS1 Table C.3.1.1
- Pre-drill holes 0.5mm to 1mm smaller than the nail gauge. Example: For a 75mm nail, use a 2.5mm drill
- Nail with slight (0-2°) upward slope
- Fixings to achieve a minimum of 30mm penetration into the framing
- Fixings to be minimum 30mm from the ends of boards
- Nailed 10mm above the top of the lower board
- Do not rely on clinch nails for spacing

Cavity battens:

- Will be fixed by the cladding fixings, which will penetrate the wall framing. Battens only need temporary fixing until the cladding is fixed (E2/AS1 - Table C.3.1.1)
- Must always be installed sloping away from the framing
- Must have a 5-10mm gap between them

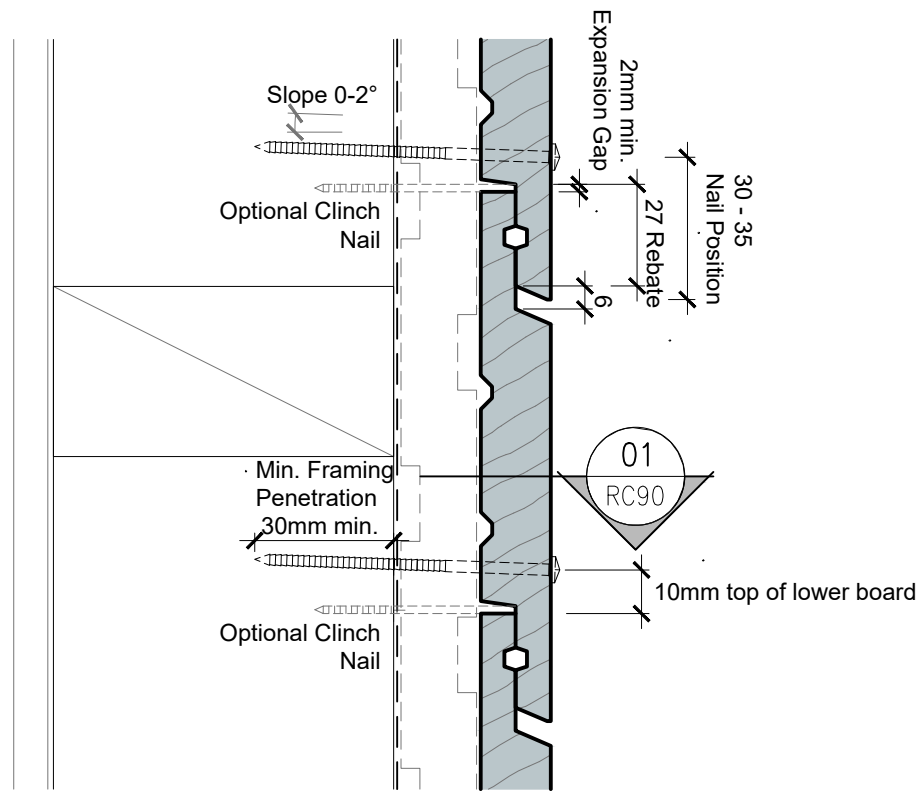

Cross Section 02



DRAWING SCALE 1:2 @ A4	ISSUE DATE 11/02/2026
DRAWING NUMBER JSC 20CF RC91	VERSION 2.6

SEQUENCE :

- | | |
|--------------------------|--|
| 1. Roof and Wall Framing | 8. Apron Flashing |
| 2. Wall Underlay | 9. Wall Underlay (lap over Apron Flashing) |
| 3. Cavity Battens | 10. Cavity Closure |
| 4. Transition Flashing | 11. Cavity Battens (above Apron Flashing) |
| 5. Fascia Board | 12. Corner Flashing |
| 6. Roof Underlay | 13. Cladding |
| 7. Roofing | 14. Gutter |

Transition tray flashing extended to underside of roofing according to E2/AS1 Figure 5.1.2.4

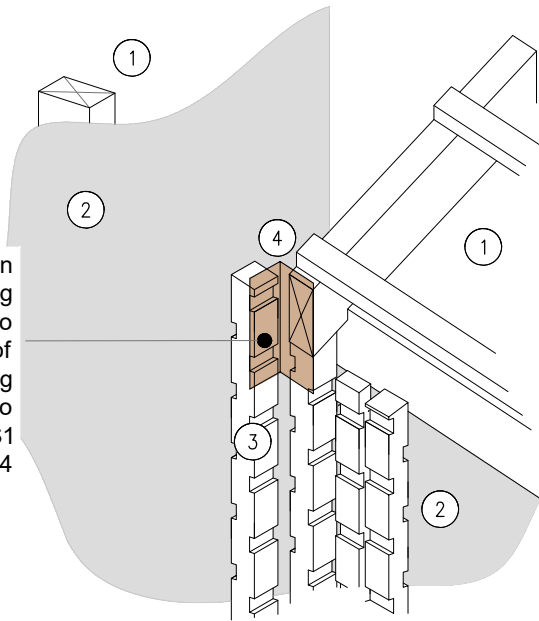

STAGE ONE

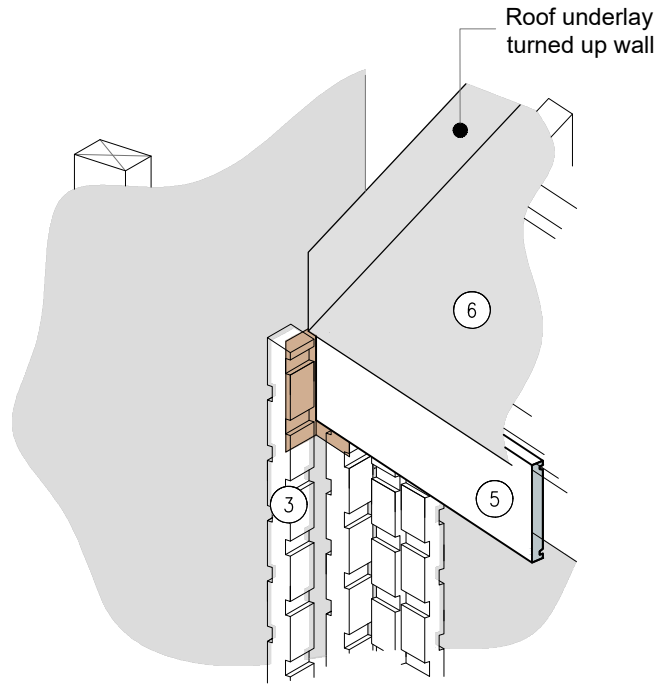

STAGE TWO

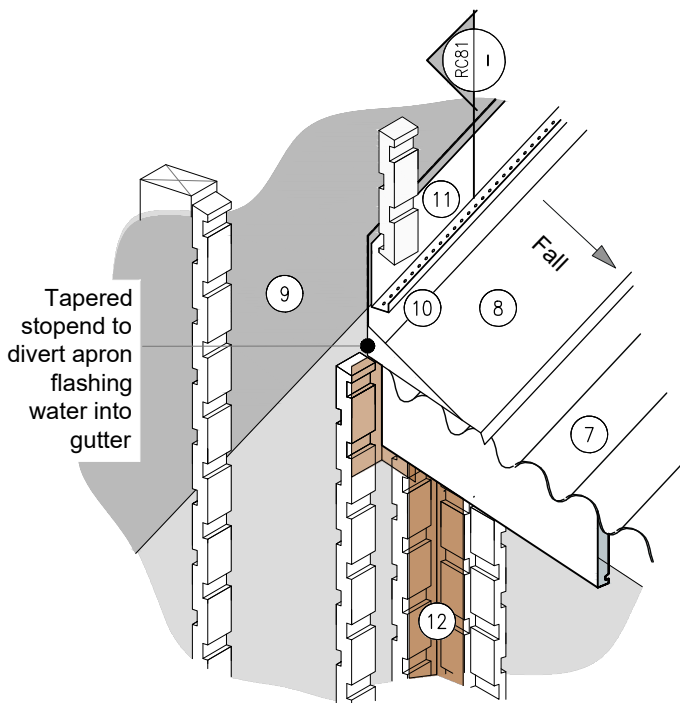

STAGE THREE

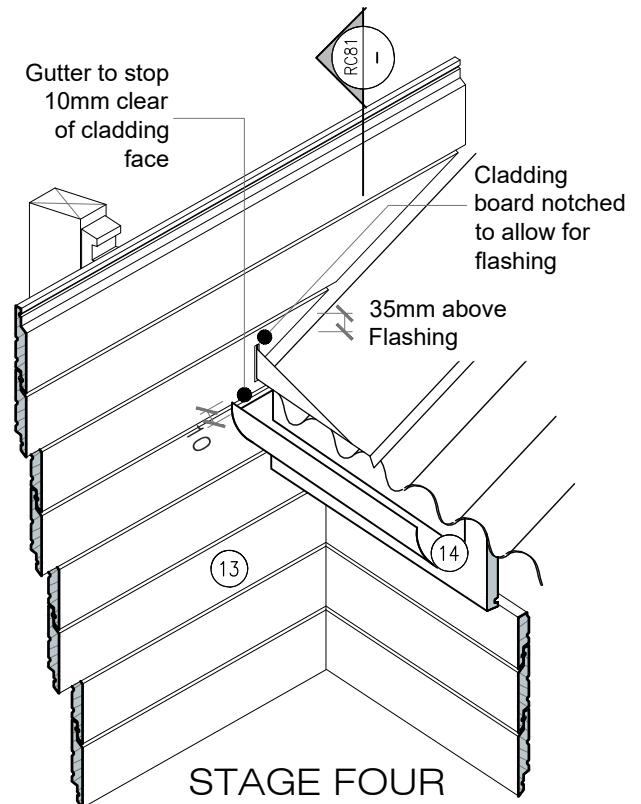

STAGE FOUR

CodeMark
CMNZ30081

