

# TECHNICAL DRAWINGS

JSC VERTICLAD Vertical Shiplap Weatherboards Flexible Underlay 45mm Cavity Fix

ISSUE : 11/02/2026 | VERSION : 2.6

© J SCOTT & COMPANY LIMITED 2026



Eastern Beach Home | Matt Brew Architect  
Photo: Jamie Cobel

**CodeMark**  
CMNZ30084



[jsc.co.nz](http://jsc.co.nz)  
TechHelp@jsc.co.nz | (09) 412 2812

**TYPE**  
VERTICAL SHIPLAP WB - 45mm CAVITY FIX

**NAME**  
COVER SHEET

- TO BE READ IN CONJUNCTION WITH COMPLETE JSC VERTICLAD SYSTEM LITERATURE
- DETAILS MAY BE SUBJECT TO CHANGE WITHOUT NOTICE



SCAN IT FOR MORE INFORMATION

<b>DRAWING SCALE</b> N.T.S.	<b>ISSUE DATE</b> 11/02/2026
--------------------------------	---------------------------------

<b>DRAWING NUMBER</b> JSC 45CF VS01	<b>VERSION</b> 2.6
--	-----------------------

# INDEX

ISSUE : 11/02/2026 | VERSION : 2.6

© J SCOTT & COMPANY LIMITED 2026

Sheet Number	Sheet Title
JSC 45CF VS01	COVER SHEET
JSC 45CF VS02	INDEX
JSC 45CF VS03	GENERAL NOTES
JSC 45CF VS04	RELATED DOCUMENTS
JSC 45CF VS10	Window Head Detail
JSC 45CF VS11	Window Sill Detail
JSC 45CF VS12	Window Jamb Detail - Scriber
JSC 45CF VS13	Window Jamb Detail - No Scriber
JSC 45CF VS30	Square Utility Head Detail
JSC 45CF VS31	Square Utility Sill Detail
JSC 45CF VS32	Square Utility Jamb Detail
JSC 45CF VS40	Weatherboard Scarf Joint
JSC 45CF VS41	Vertical Control Joint
JSC 45CF VS42	Base of Wall, Concrete
JSC 45CF VS43	Base of Wall, Timber
JSC 45CF VS44	Pipe Penetration
JSC 45CF VS50	External Corner - J40
JSC 45CF VS51	3D - External Corner - J40
JSC 45CF VS52	External Corner - APJC5
JSC 45CF VS53	3D - External Corner - APJC5
JSC 45CF VS54	External Corner - J42
JSC 45CF VS55	3D - External Corner - J42
JSC 45CF VS60	Internal Corner - J44
JSC 45CF VS61	3D - Internal Corner - J44
JSC 45CF VS62	Internal Corner
JSC 45CF VS63	3D - Internal Corner
JSC 45CF VS64	External Corner - Box Corner
JSC 45CF VS65	3D External Corner - Box Corner
JSC 45CF VS70	Base of Wall, Membrane Roof
JSC 45CF VS71a	Parapet Saddle Flashing - Stage One
JSC 45CF VS71b	Parapet Saddle Flashing - Stage Two
JSC 45CF VS71c	Parapet Saddle Flashing - Stage Three
JSC 45CF VS71d	Parapet Saddle Flashing - Stage Four
JSC 45CF VS75	Parapet Detail
JSC 45CF VS77	Decorative Bracket - Batten Detail
JSC 45CF VS80	Inter Storey Joint
JSC 45CF VS81	Apron Flashing Roof To Wall Junction
JSC 45CF VS82	Soffit Detail at Wall
JSC 45CF VS83	Soffit Detail at Fascia
JSC 45CF VS84	Raking Soffit Detail at Wall
JSC 45CF VS85	Gable Soffit Detail at Wall
JSC 45CF VS90	Weatherboard Fixing - Plan Section
JSC 45CF VS91	Weatherboard Fixing - Cross Section
JSC 45CF VS92	Apron Flashing Gutter to Wall Junction

CodeMark  
CMNZ30084



jsc.co.nz  
TechHelp@jsc.co.nz | (09) 412 2812

TYPE  
VERTICAL SHIPLAP WB - 45mm CAVITY FIX

NAME  
INDEX

• TO BE READ IN CONJUNCTION WITH COMPLETE JSC VERTICLAD SYSTEM LITERATURE  
• DETAILS MAY BE SUBJECT TO CHANGE WITHOUT NOTICE



SCAN IT FOR MORE  
INFORMATION

DRAWING SCALE N.T.S.	ISSUE DATE 11/02/2026
DRAWING NUMBER JSC 45CF VS02	VERSION 2.6

# GENERAL NOTES

ISSUE : 11/02/2026 | VERSION : 2.6

© J SCOTT & COMPANY LIMITED 2026

## OVERVIEW :

JSC VertiClad is a cavity based external wall cladding system comprising of:

- Timber weatherboards finished with high quality exterior grade coating
- H3.2 treated timber castellated cavity battens
- Fascia boards and moulding profiles

This documentation covers the installation guide for fixing JSC Vertical Shiplap weatherboards over JSC-H 45x45 or JSC 70X45 castellated cavity battens.

## SCOPE OF USE:

- This document is for use within the scope of JSC VertiClad Vertical Shiplap Weatherboard Cladding System technical documentation and Code Compliance CodeMark certificate [CMNZ 30084](#).
- For scope, conditions and limitations of use refer to CodeMark certificate [CMNZ 30084](#).
- Details are subject to change without notification and only the current version is compliant. Refer to [jsc.co.nz](#) at the time of use for the current documentation.
- The designer/specifier must be satisfied that these details are applicable for their intended use.

## FIXING SPECIFICATION:

- Western Red Cedar, Alaskan Yellow Cedar, Radiata Pine and Nordic Pine, TMT Taiga, TMT Taxon, TMT Tuscan, TMT Amba, TMT ThermoPine and TMT ThermoPine H3.2: Fixing material to be 316 Stainless Steel or Silicon Bronze annular grooved nails
- For the use of any alternative fixing of equivalent properties refer to [E2/AS1 Table C.3.1.1](#) and to [E2/AS1 Table C.1.1.1A](#) for alternative material selection.
- JSC recommends nail materials as per [VertiClad Installation Guide Table 3 - Nail Fixings](#), as they will at least match the expected life of the cladding. E2/AS1 allows the use of galvanised fixings, although JSC does not endorse their use.
- Jolt head nails are only suitable for paint finished weatherboards.
- For buildings located in exposure 'Zone D', 316 stainless steel fixings must be used as per [NZS 3604:2011](#).

## PRE INSTALLATION:

- Weatherboards must be dry and free of any contamination.
- Board lengths must be optimised prior to the installation to avoid any unnecessary wastage and joints.
- Any loose, bark encased knots, or other timber defects need to be removed.
- Weatherboards must be coated with suitable exterior coating on all sides in accordance with coating manufacturer's specification.

## INSTALLATION:

- JSC VertiClad System must be installed by a suitably qualified and experienced trade person. Where Restricted Building Work (RBW) applies the installer shall be a Licensed Building Practitioner (LBP) or supervised by LBP.
- Compatibility of materials as per [Tables C.1.1.1A - C.1.1.1C E2/AS1](#).
- Rigid and flexible underlay as per [E2/AS1 Table C.2.1.1](#) and [Clauses 9.1.4 to 9.1.6 E2/AS1](#) or proprietary approved alternative.
- The weatherboard system shall incorporate joinery that meets the requirements of New Zealand Building Code for the relevant building wind zone or wind pressure.
- Where weatherboards have an exposed bottom edge, the back of the boards should be cut with a 15° drip edge and the cut end should be coated to 150-200mm up from the bottom edge.
- Cavity closer/vermin proofing must be installed continuously around the bottom of the cavity positioned to give a 15mm min. drip edge to cladding.
- Cavity closer/vermin proofing openings must be kept clear and unobstructed to maintain draining and venting of the cavity.
- Windows and doors to be installed as per manufacturer's specifications, head flashing stop ends must be in place. Flashings as per [E2/AS1 Part 4](#).
- Flashings as per [E2/AS1 Part 4](#) at corners, doors, windows and wall intersections must be installed to prevent water from crossing the cavity.
- Sealant to be compatible with the final coating system and to be applied as per manufacturer's instructions and specifications. For JSC Coating products refer to [JSC Coatings Wood Oil Range Guide](#).

## MAINTENANCE:

- Annual inspection and cleaning followed by repair to any damaged areas. Refer to [JSC Maintenance Guide](#).

CodeMark  
CMNZ30084



# RELATED DOCUMENTS

ISSUE : 11/02/2026 | VERSION : 2.6

© J SCOTT & COMPANY LIMITED 2026

- MBIE NZ Building Code Clause E2 External Moisture (refer to [E2 External moisture](#))
- Department of Building and Housing (DBH). [Constructing cavities for wall claddings](#)
- BRANZ Bulletin BU468 [December 2005] Fixing Timber Weatherboards (refer to [www.branz.co.nz/BU468](http://www.branz.co.nz/BU468))
- [BRANZ \[May 2015\] Good Practice Guide: Timber Cladding](#)
- [BRANZ Build 154-33- Build Right Structurally Fixed Cavity Battens](#)
- [BRANZ Build 173-28- Build Right Coatings for Timber Weatherboards](#)
- [BRANZ Bulletin BU531 \[February 2011\] Designing for Thermal and Moisture Movement](#)
- Window & Glass Association NZ - WGANZ ([www.wganz.org.nz](http://www.wganz.org.nz))
- [NZS AS 1720.1:2022](#)
- [NZS 3604:2011 Timber-framed buildings](#)

**Disclaimer:** It is the responsibility of the designer/specifier to ensure the suitability and specification of any third-party accessories used with our cladding system. JSC is not liable for the installation of any components or accessories not supplied by us. For guidance on using specific components, please refer to our Technical Installation Details and Installation Guides. If there is any uncertainty, please seek expert advice.

The related documents mentioned above were accurate and up to date at the time of writing this guide. However, please note that information may have changed since then, and we recommend verifying any external sources for the most current information.

CodeMark  
CMNZ30084



[jsc.co.nz](http://jsc.co.nz)  
TechHelp@jsc.co.nz | (09) 412 2812

TYPE  
VERTICAL SHIPLAP WB - 45mm CAVITY FIX

NAME  
RELATED DOCUMENTS

- TO BE READ IN CONJUNCTION WITH COMPLETE JSC VERTICLAD SYSTEM LITERATURE
- DETAILS MAY BE SUBJECT TO CHANGE WITHOUT NOTICE



SCAN IT FOR MORE  
INFORMATION

DRAWING SCALE N.T.S.	ISSUE DATE 11/02/2026
DRAWING NUMBER JSC 45CF VS04	VERSION 2.6

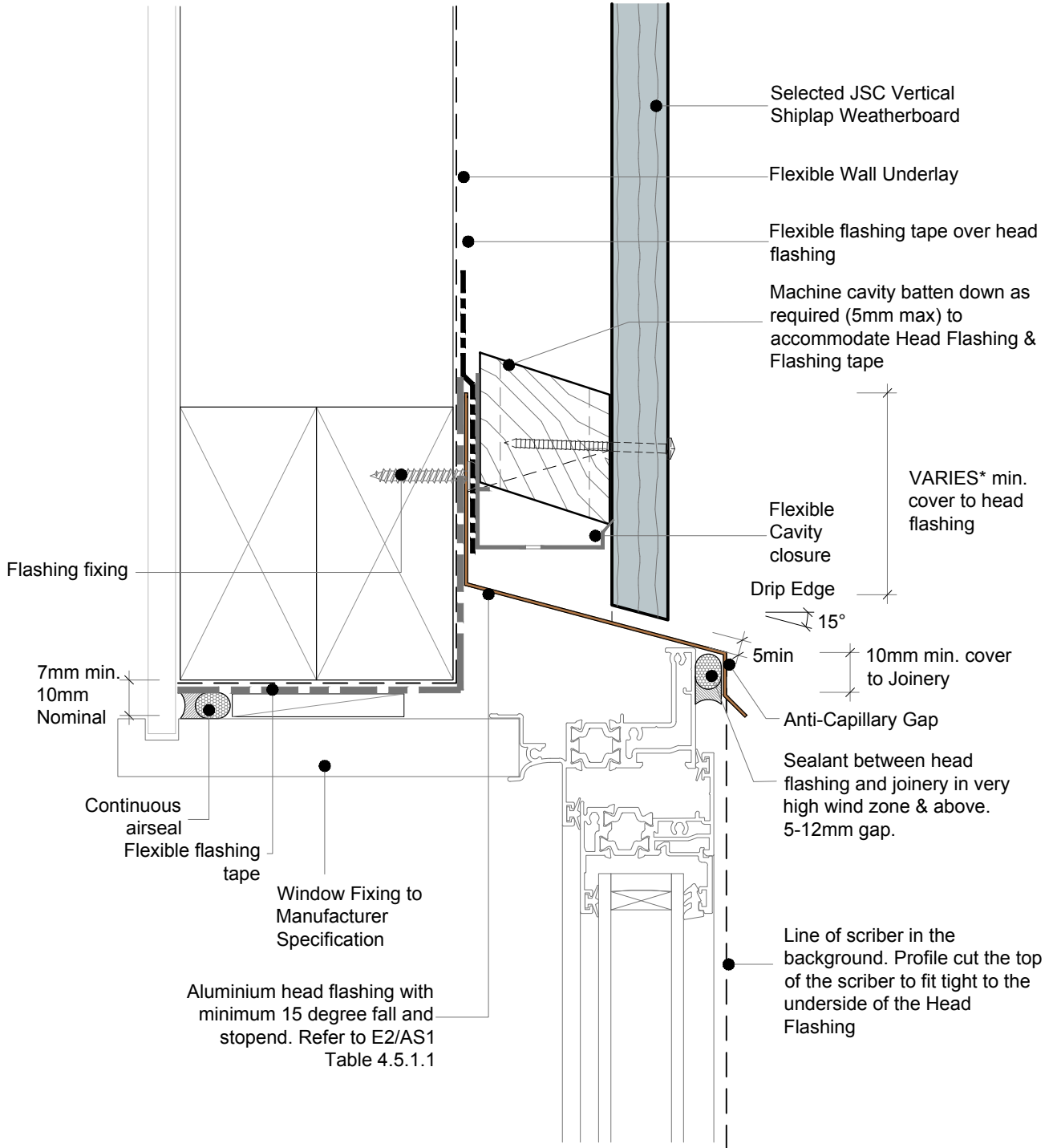

**NOTE:**

- To address the buildup of elements on the head detail, consider the use of a flexible cavity closer.

\*JSC recommends no hooks or hems. Therefore, the flashing upstand dimensions must be increased by 25 mm in accordance with E2/AS1, Section 4.4.3

• TO BE READ IN CONJUNCTION WITH COMPLETE JSC VERTICLAD SYSTEM LITERATURE

**CodeMark**  
CMNZ30084



<b>DRAWING SCALE</b> 1:2 @ A4	<b>ISSUE DATE</b> 11/02/2026
<b>DRAWING NUMBER</b> JSC 45CF VS10	<b>VERSION</b> 2.6

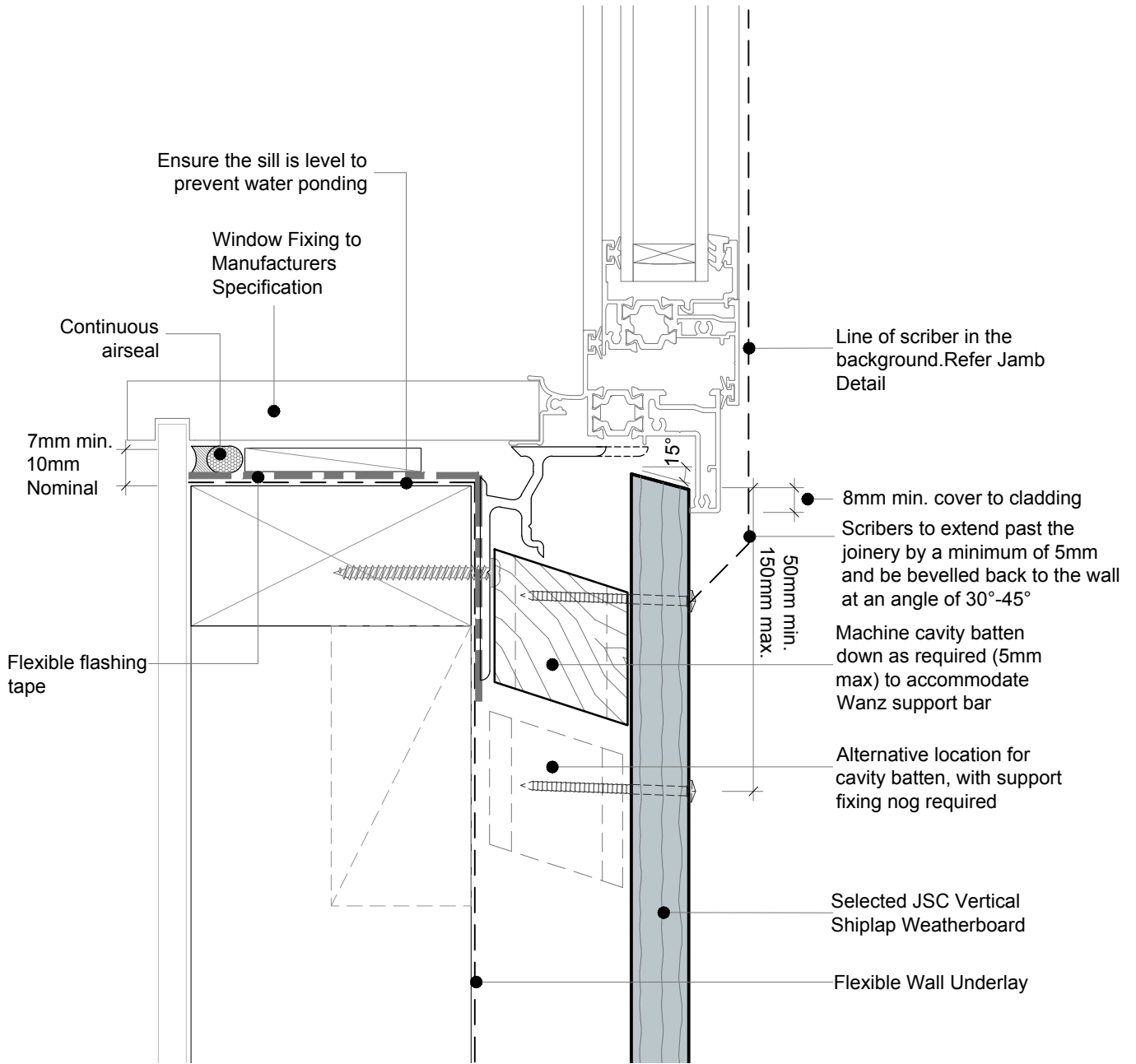

• TO BE READ IN CONJUNCTION WITH COMPLETE JSC VERTICLAD SYSTEM LITERATURE

**CodeMark**  
CMNZ30084



jsc.co.nz  
TechHelp@jsc.co.nz | (09) 412 2812

**TYPE**  
VERTICAL SHIPLAP WB - 45mm CAVITY FIX

**NAME**  
Window Sill Detail

• DETAILS MAY BE SUBJECT TO CHANGE WITHOUT NOTICE



SCAN IT FOR MORE INFORMATION

<b>DRAWING SCALE</b> 1:2 @ A4	<b>ISSUE DATE</b> 11/02/2026
----------------------------------	---------------------------------

<b>DRAWING NUMBER</b> JSC 45CF VS11	<b>VERSION</b> 2.6
--	-----------------------

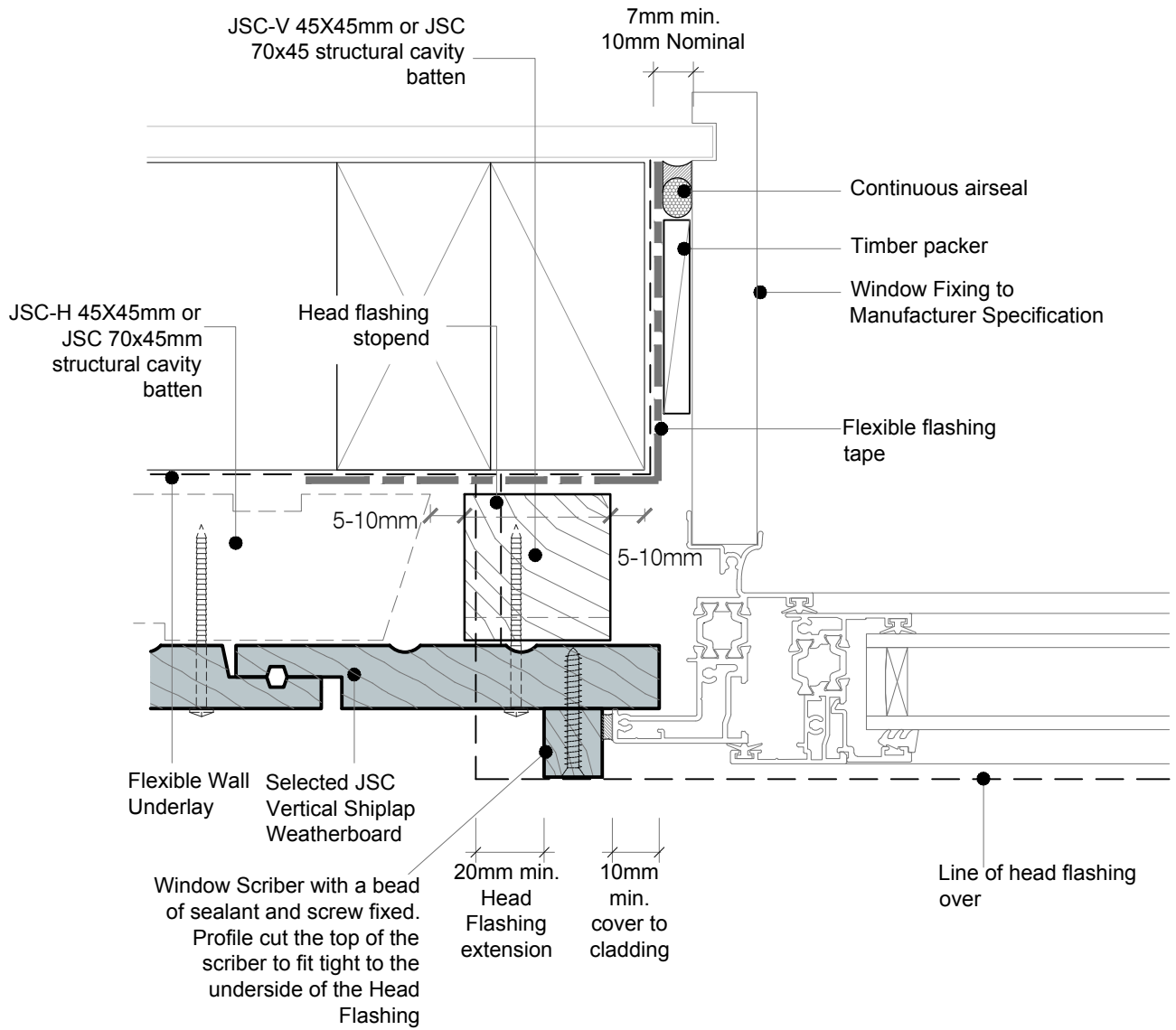

• TO BE READ IN CONJUNCTION WITH COMPLETE JSC VERTICLAD SYSTEM LITERATURE

**CodeMark**  
CMNZ30084



<b>DRAWING SCALE</b> 1:2 @ A4	<b>ISSUE DATE</b> 11/02/2026
<b>DRAWING NUMBER</b> JSC 45CF VS12	<b>VERSION</b> 2.6

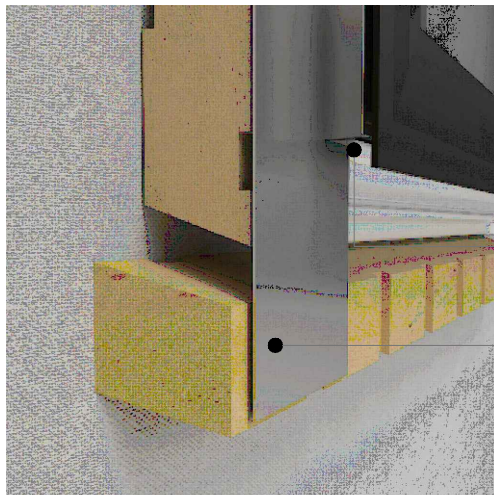
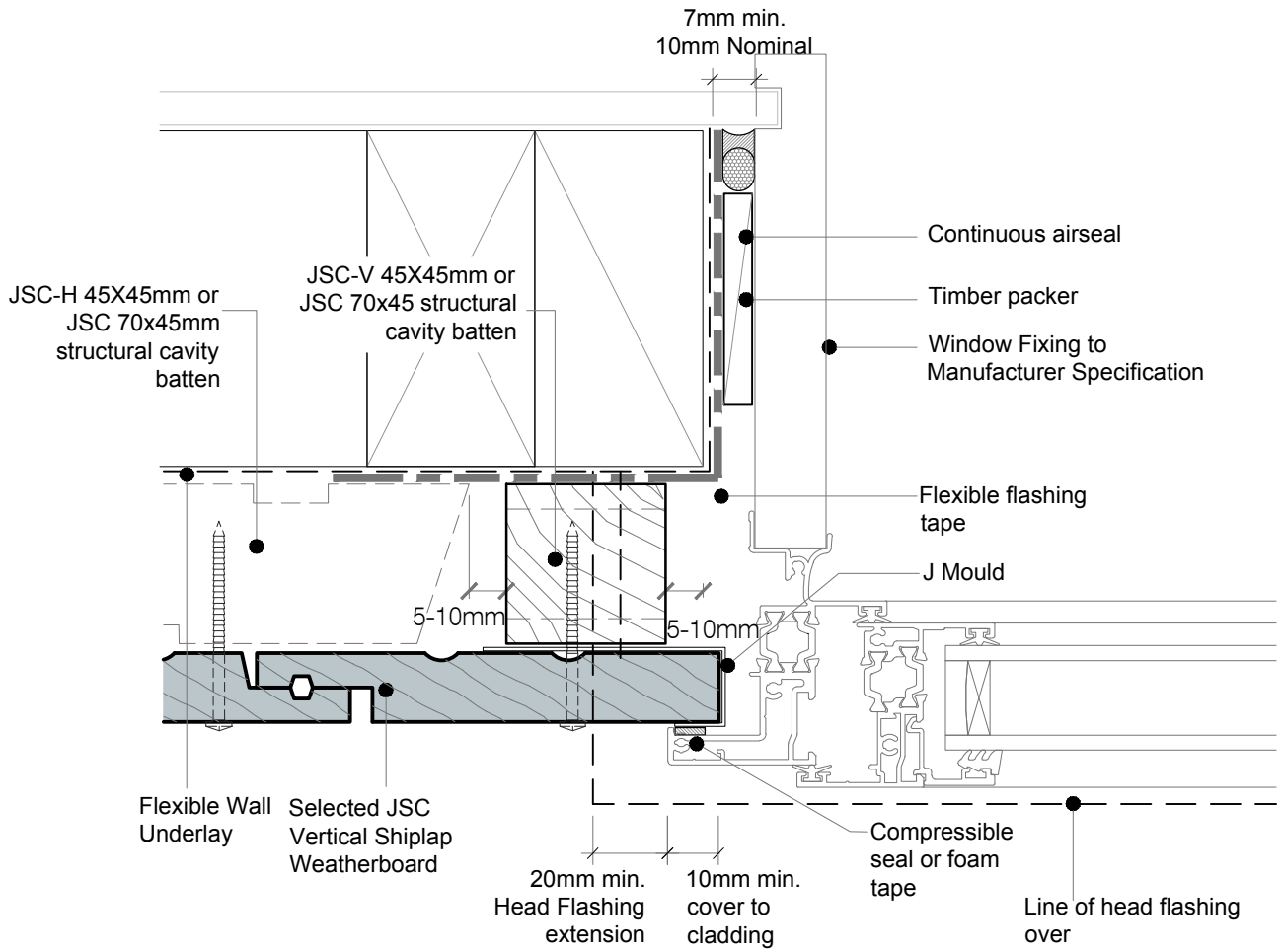

Cut and fold J Mould

J Mould to extend past sill cavity batten

**NOTE : No Scriber Option :**  
 The Aluminium Joinery must sit hard against the back of the joinery flange and the timber weatherboards with a seal or foam tape in between.

• TO BE READ IN CONJUNCTION WITH COMPLETE JSC VERTICLAD SYSTEM LITERATURE

**CodeMark**  
 CMNZ30084



<b>DRAWING SCALE</b> 1:2 @ A4	<b>ISSUE DATE</b> 11/02/2026
<b>DRAWING NUMBER</b> JSC 45CF VS13	<b>VERSION</b> 2.6

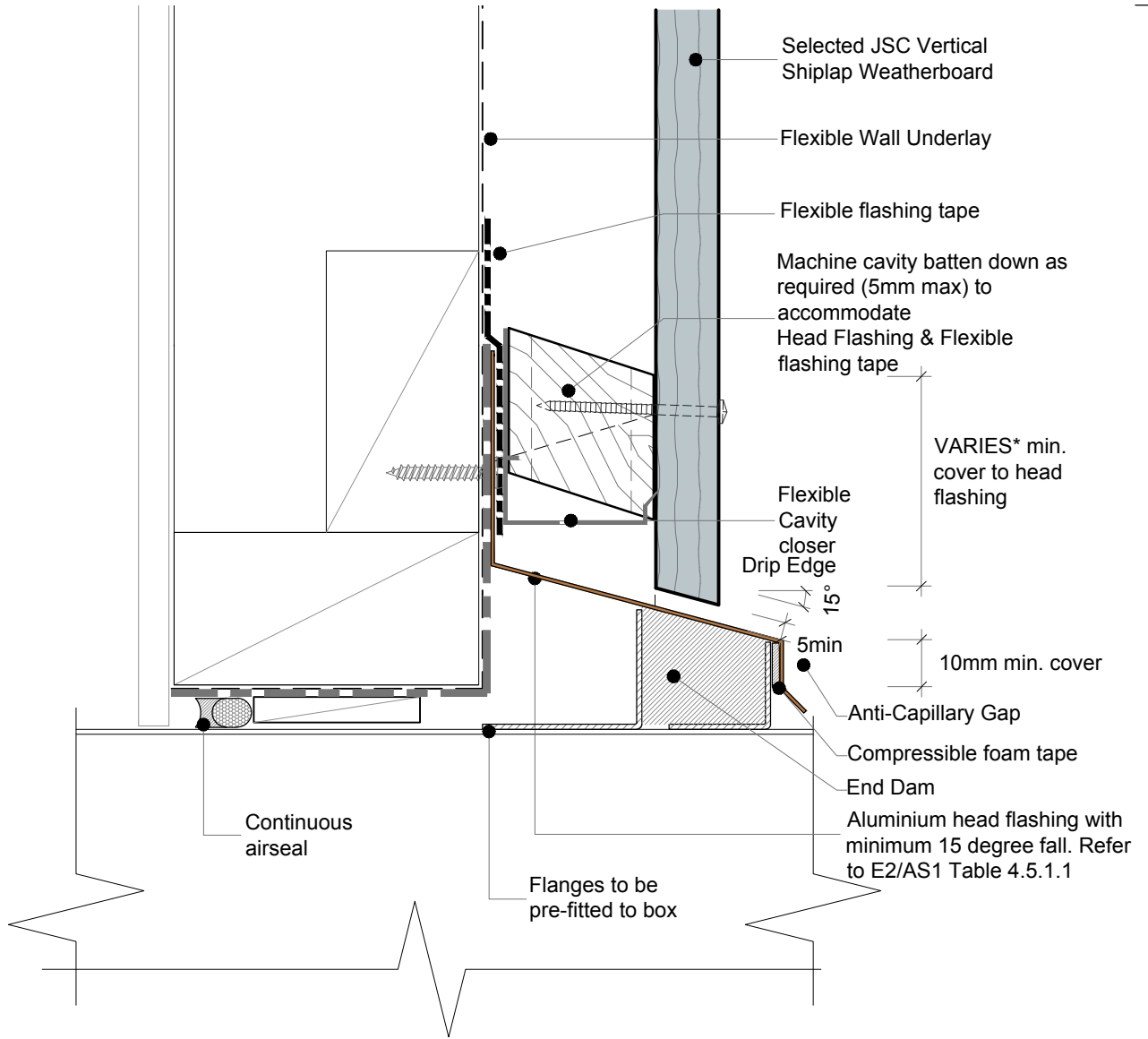

**NOTE:**

- Ensure a minimum penetration of 30mm into the timber frame due to the presence of multiple elements, including cavity batten, flashing tape, cavity closure, and head flashing.
- To address the buildup of elements on the head detail, consider the use of a flexible cavity closer.

\*JSC recommends no hooks or hems. Therefore, the flashing upstand dimensions must be increased by 25 mm in accordance with E2/AS1, Section 4.4.3

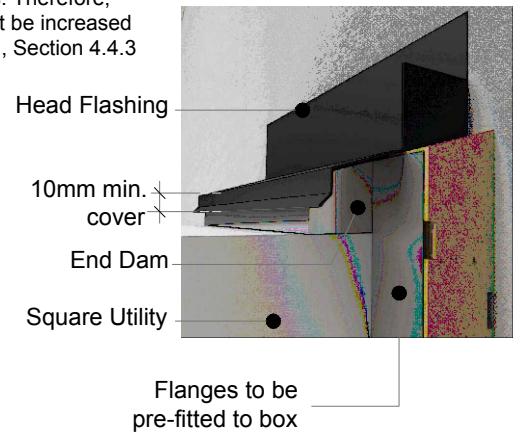
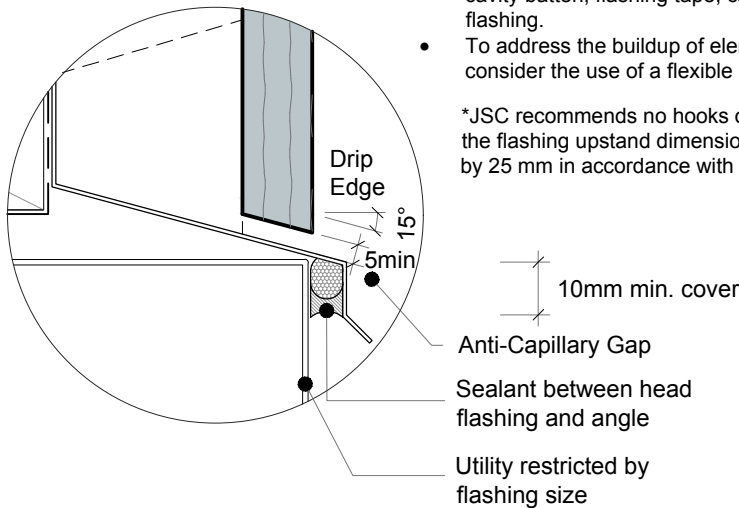

• TO BE READ IN CONJUNCTION WITH COMPLETE JSC VERTICLAD SYSTEM LITERATURE

**CodeMark**  
CMNZ30084



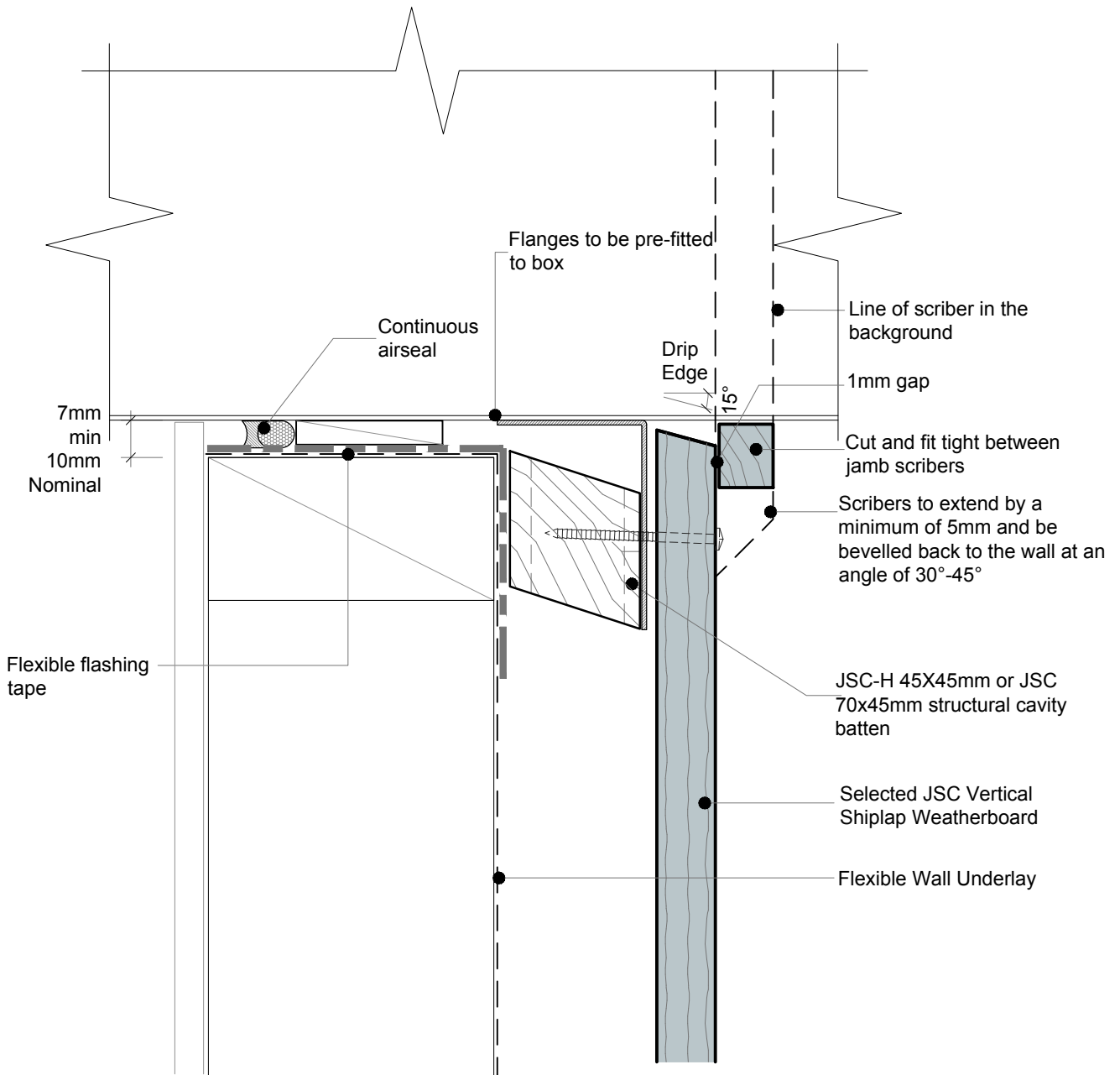

• TO BE READ IN CONJUNCTION WITH COMPLETE JSC VERTICLAD SYSTEM LITERATURE

**CodeMark**  
CMNZ30084



jsc.co.nz  
TechHelp@jsc.co.nz | (09) 412 2812

**TYPE**  
VERTICAL SHIPLAP WB - 45mm CAVITY FIX

**NAME**  
Square Utility Sill Detail

• DETAILS MAY BE SUBJECT TO CHANGE WITHOUT NOTICE



SCAN IT FOR MORE INFORMATION

<b>DRAWING SCALE</b> 1:2 @ A4	<b>ISSUE DATE</b> 11/02/2026
<b>DRAWING NUMBER</b> JSC 45CF VS31	<b>VERSION</b> 2.6

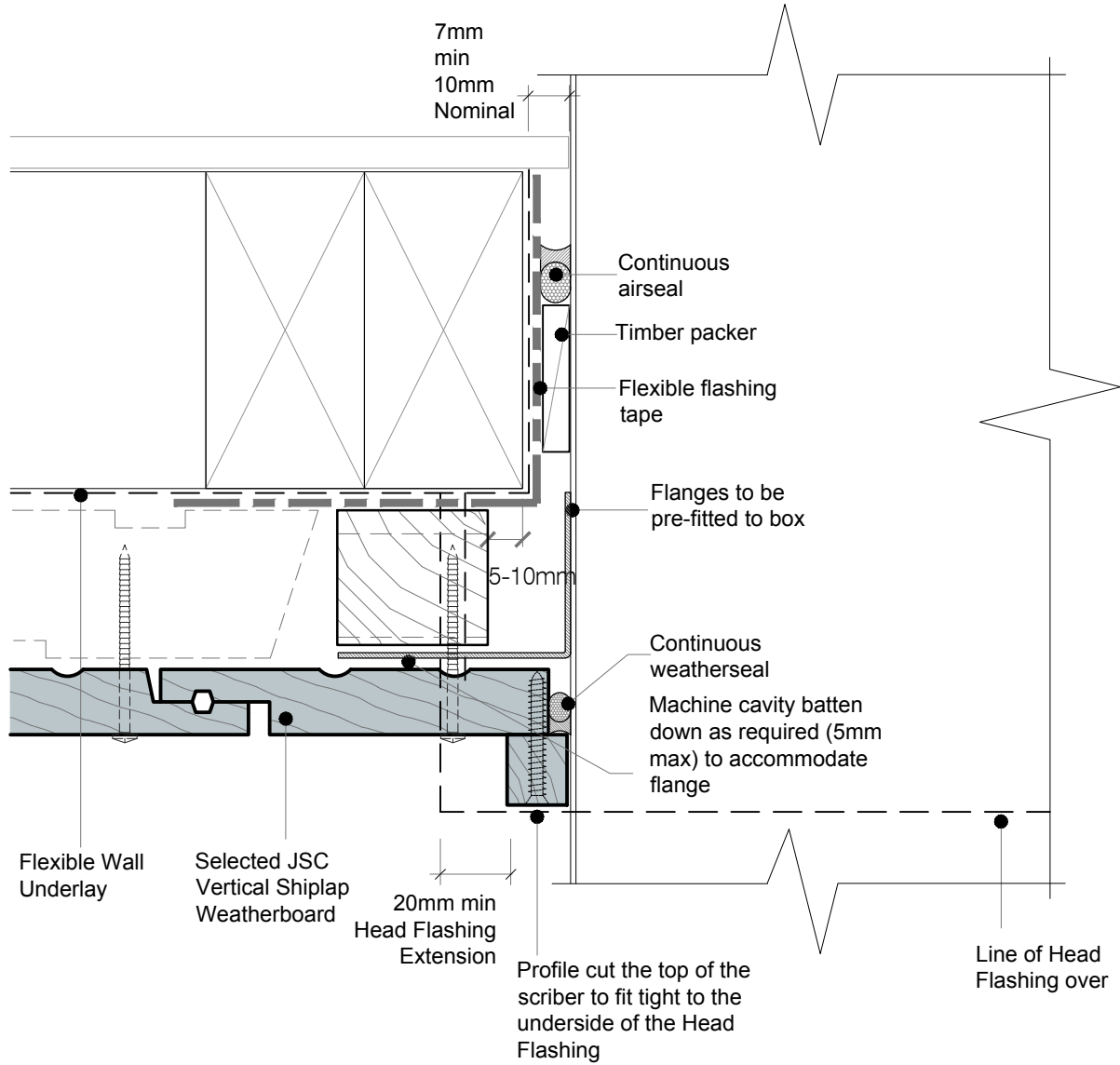

• TO BE READ IN CONJUNCTION WITH COMPLETE JSC VERTICLAD SYSTEM LITERATURE

**CodeMark**  
CMNZ30084



jsc.co.nz  
TechHelp@jsc.co.nz | (09) 412 2812

**TYPE**  
VERTICAL SHIPLAP WB - 45mm CAVITY FIX

**NAME**  
Square Utility Jamb Detail

• DETAILS MAY BE SUBJECT TO CHANGE WITHOUT NOTICE



SCAN IT FOR MORE INFORMATION

**DRAWING SCALE**  
1:2 @ A4

**ISSUE DATE**  
11/02/2026

<b>DRAWING NUMBER</b> JSC 45CF VS32	<b>VERSION</b> 2.6
--	-----------------------

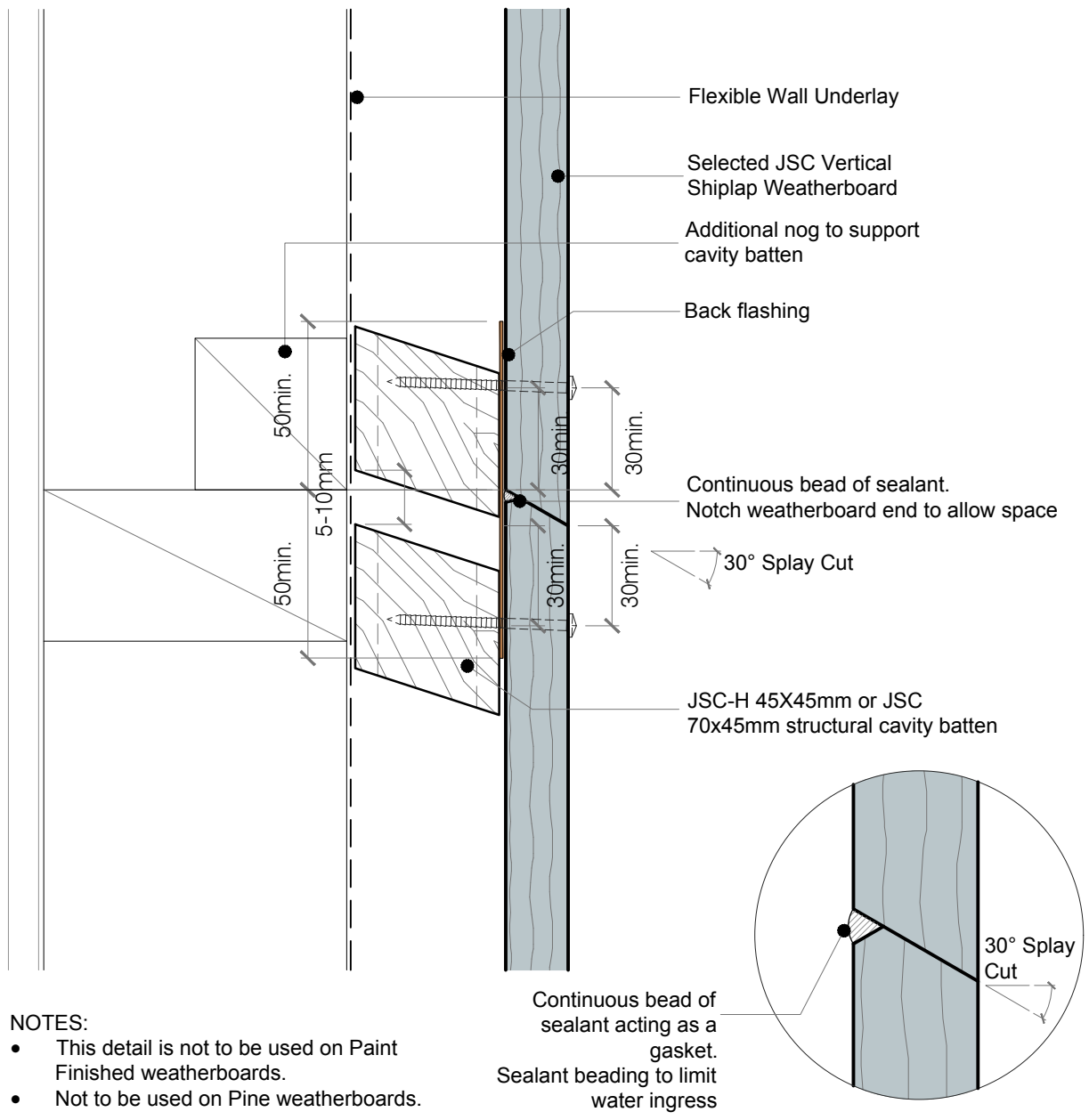

- NOTES:
- This detail is not to be used on Paint Finished weatherboards.
  - Not to be used on Pine weatherboards.

• TO BE READ IN CONJUNCTION WITH COMPLETE JSC VERTICLAD SYSTEM LITERATURE

**CodeMark**  
 CMNZ30084



<b>DRAWING SCALE</b> 1:2 @ A4	<b>ISSUE DATE</b> 11/02/2026
<b>DRAWING NUMBER</b> JSC 45CF VS40	<b>VERSION</b> 2.6

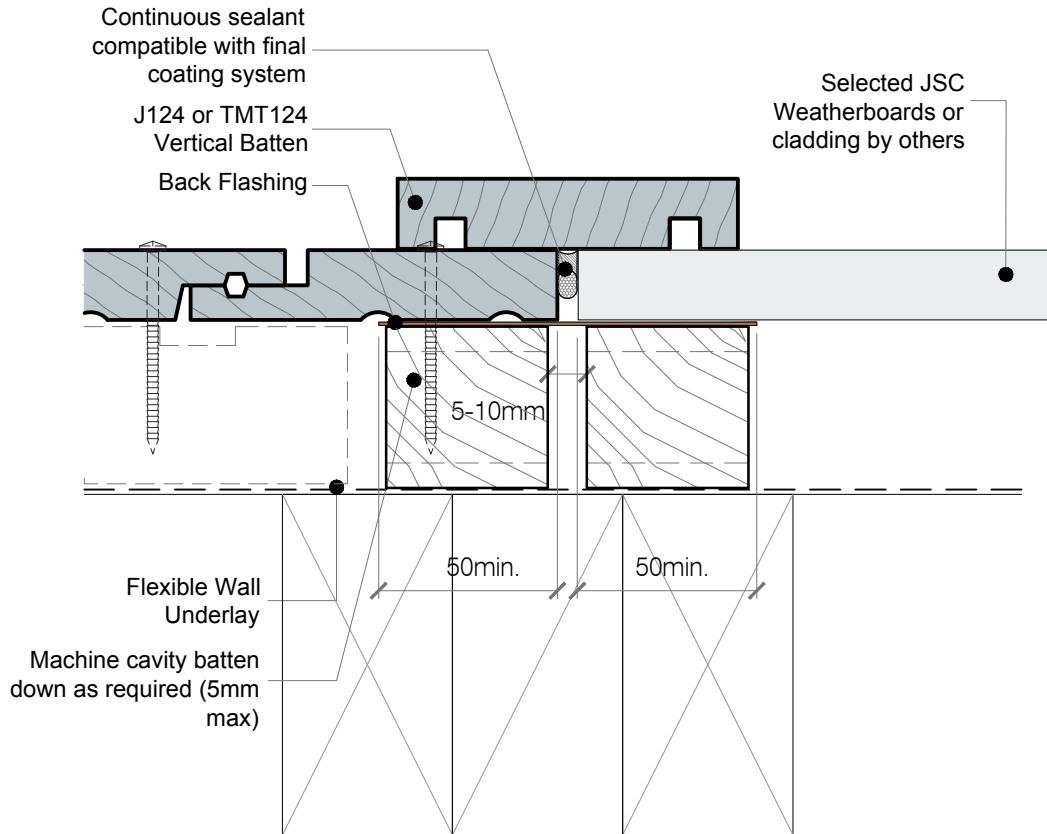

• TO BE READ IN CONJUNCTION WITH COMPLETE JSC VERTICLAD SYSTEM LITERATURE

**CodeMark**  
 CMNZ30084



<b>DRAWING SCALE</b> 1:2 @ A4	<b>ISSUE DATE</b> 11/02/2026
<b>DRAWING NUMBER</b> JSC 45CF VS41	<b>VERSION</b> 2.6

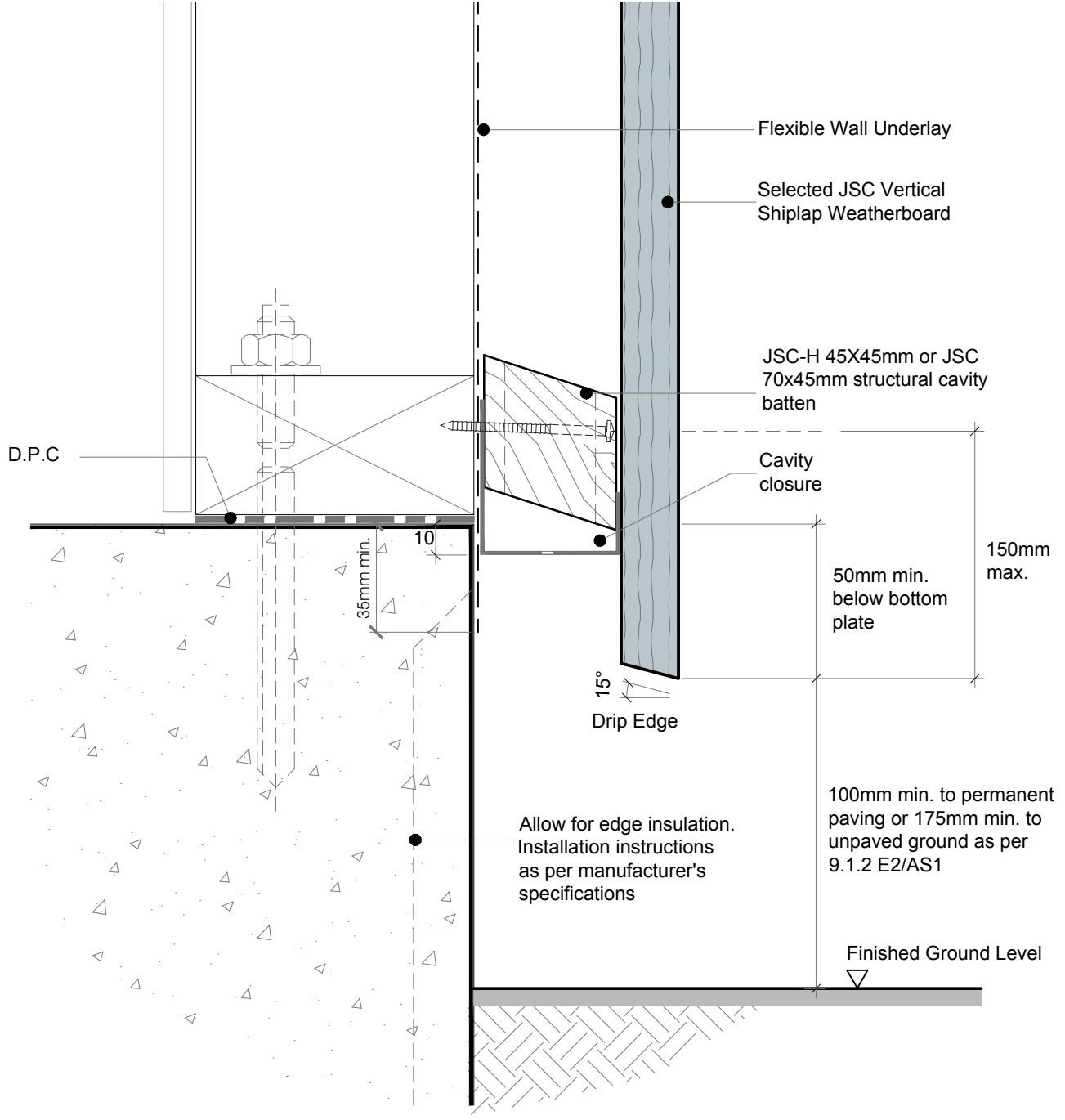

• TO BE READ IN CONJUNCTION WITH COMPLETE JSC VERTICLAD SYSTEM LITERATURE

**CodeMark**  
 CMNZ30084



jsc.co.nz  
 TechHelp@jsc.co.nz | (09) 412 2812

**TYPE**  
 VERTICAL SHIPLAP WB - 45mm CAVITY FIX

**NAME**  
 Base of Wall, Concrete

• DETAILS MAY BE SUBJECT TO CHANGE WITHOUT NOTICE



SCAN IT FOR MORE INFORMATION

DRAWING SCALE 1:2 @ A4	ISSUE DATE 11/02/2026
DRAWING NUMBER JSC 45CF VS42	VERSION 2.6

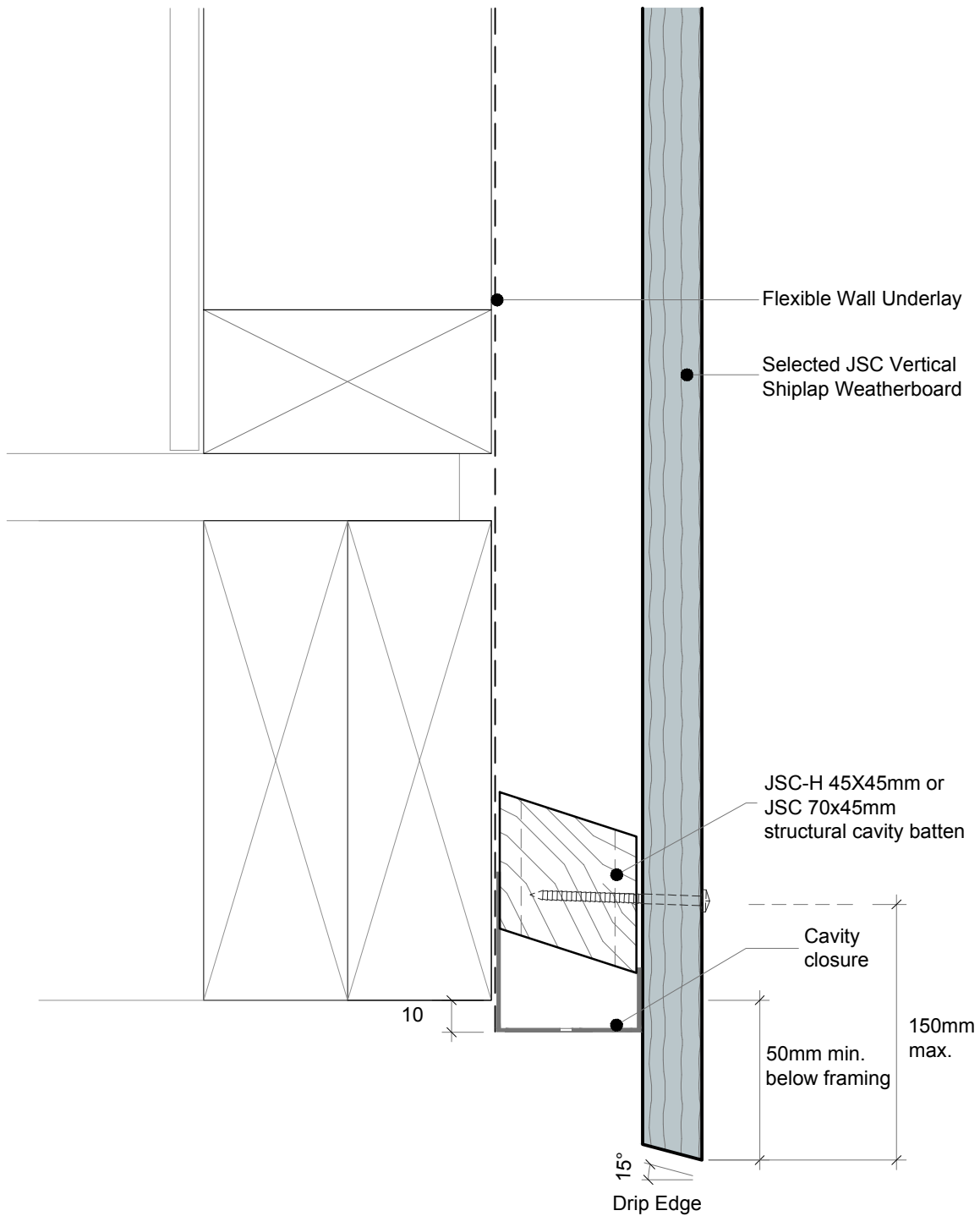

• TO BE READ IN CONJUNCTION WITH COMPLETE JSC VERTICLAD SYSTEM LITERATURE

**CodeMark**  
 CMNZ30084



jsc.co.nz  
 TechHelp@jsc.co.nz | (09) 412 2812

**TYPE**  
 VERTICAL SHIPLAP WB - 45mm CAVITY FIX

**NAME**  
 Base of Wall, Timber

• DETAILS MAY BE SUBJECT TO CHANGE WITHOUT NOTICE



SCAN IT FOR MORE INFORMATION

DRAWING SCALE 1:2 @ A4	ISSUE DATE 11/02/2026
DRAWING NUMBER JSC 45CF VS43	VERSION 2.6

-Refer to E2/AS1

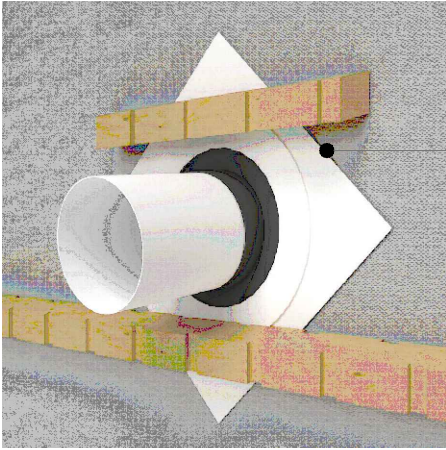

Proprietary self adhesive collar at 45°



Continuous weather seal around pipe



Sealant in the negative(s) above pipe penetration

Flange plate over pipe, sealed around pipe and top half of flange. Refer to Figure 9.1.8.3A E2/AS1

No sealant to drain

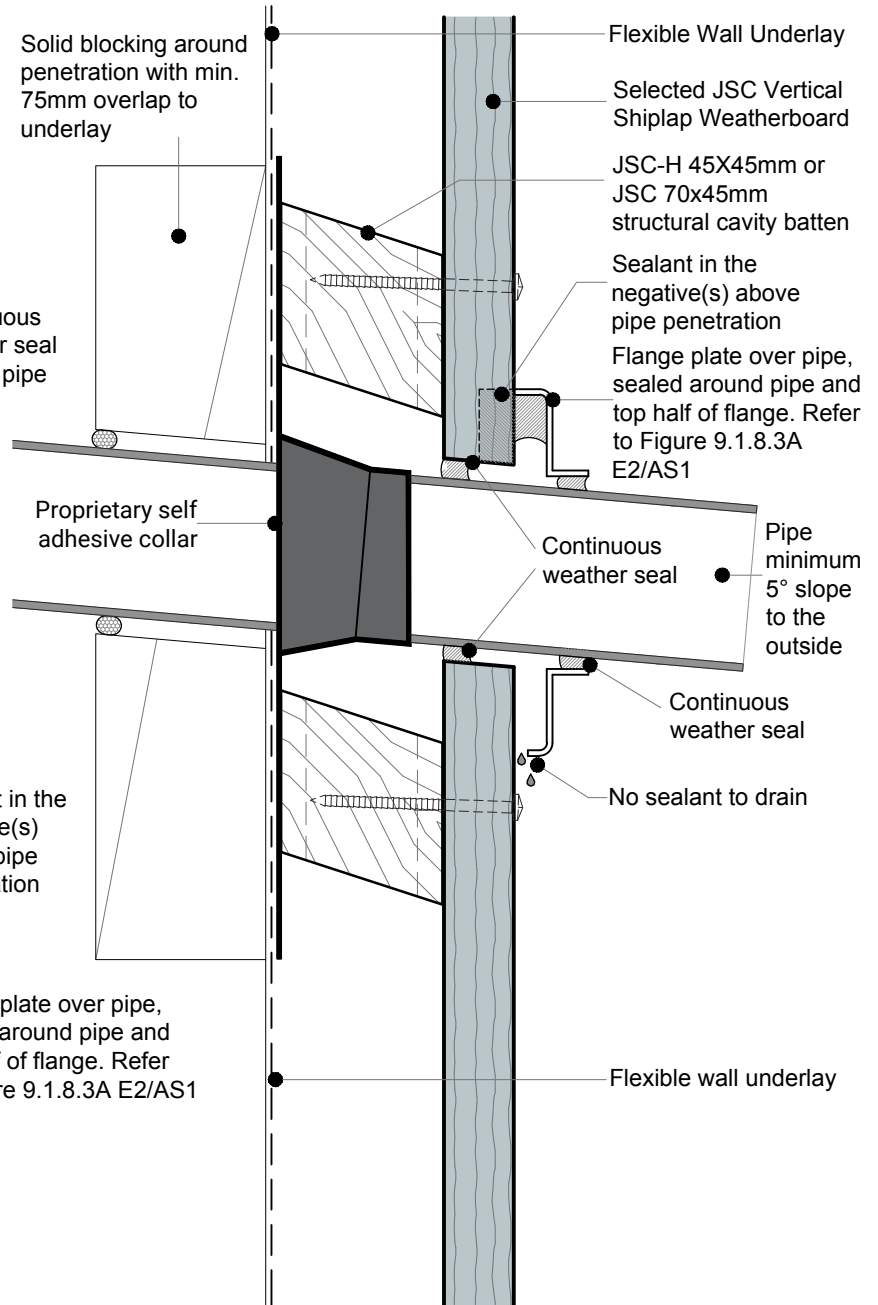

• TO BE READ IN CONJUNCTION WITH COMPLETE JSC VERTICLAD SYSTEM LITERATURE

**CodeMark**  
CMNZ30084



jsc.co.nz  
TechHelp@jsc.co.nz | (09) 412 2812

**TYPE**  
VERTICAL SHIPLAP WB - 45mm CAVITY FIX

**NAME**  
Pipe Penetration

• DETAILS MAY BE SUBJECT TO CHANGE WITHOUT NOTICE



SCAN IT FOR MORE INFORMATION

<b>DRAWING SCALE</b> 1:2 @ A4	<b>ISSUE DATE</b> 11/02/2026
<b>DRAWING NUMBER</b> JSC 45CF VS44	<b>VERSION</b> 2.6

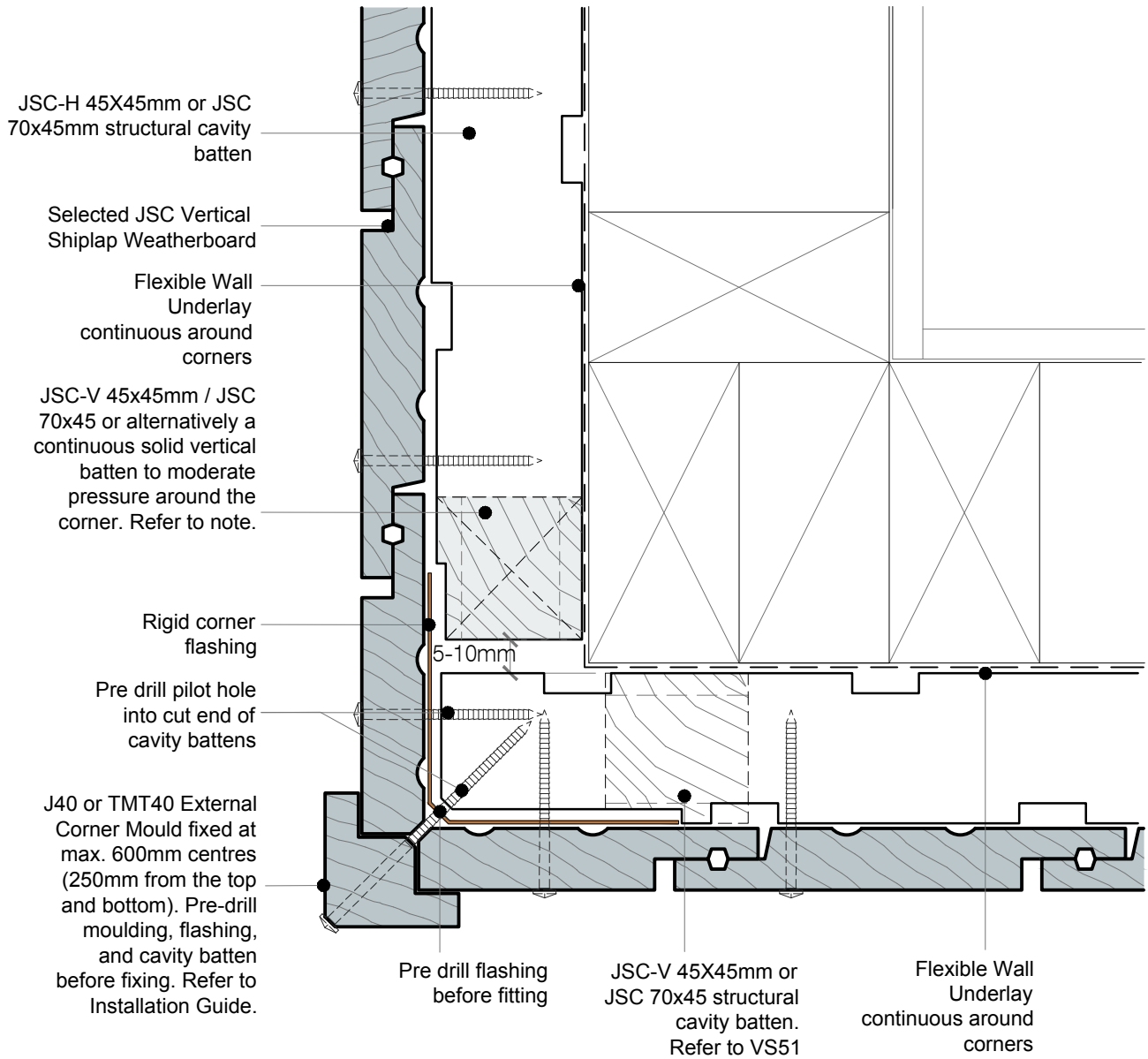

**NOTES:**

- Machine cavity battens down as required (5mm max) to accommodate corner flashing.
- For Very High (VH) and Extra High (EH) wind zones, a solid batten (non-castellated) is required down one side of a significant external corner (change in elevation) to provide pressure isolation between elevations.

• TO BE READ IN CONJUNCTION WITH COMPLETE JSC VERTICLAD SYSTEM LITERATURE

**CodeMark**  
CMNZ30084



<b>DRAWING SCALE</b> 1:2 @ A4	<b>ISSUE DATE</b> 11/02/2026
<b>DRAWING NUMBER</b> JSC 45CF VS50	<b>VERSION</b> 2.6

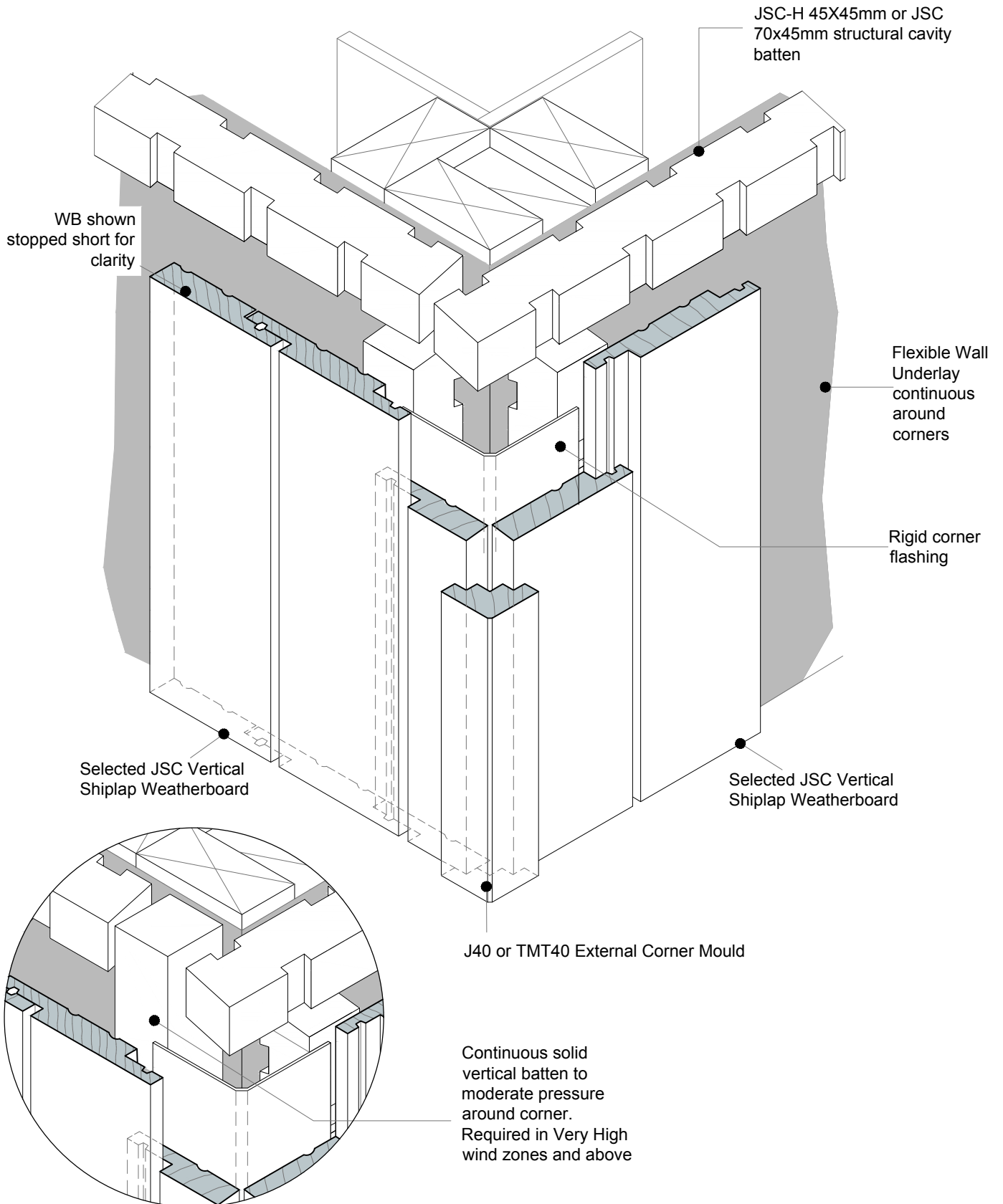

ALTERNATIVE CORNER DETAIL

• TO BE READ IN CONJUNCTION WITH COMPLETE JSC VERTICLAD SYSTEM LITERATURE

**CodeMark**  
CMNZ30084



DRAWING SCALE N.T.S.	ISSUE DATE 11/02/2026
DRAWING NUMBER JSC 45CF VS51	VERSION 2.6

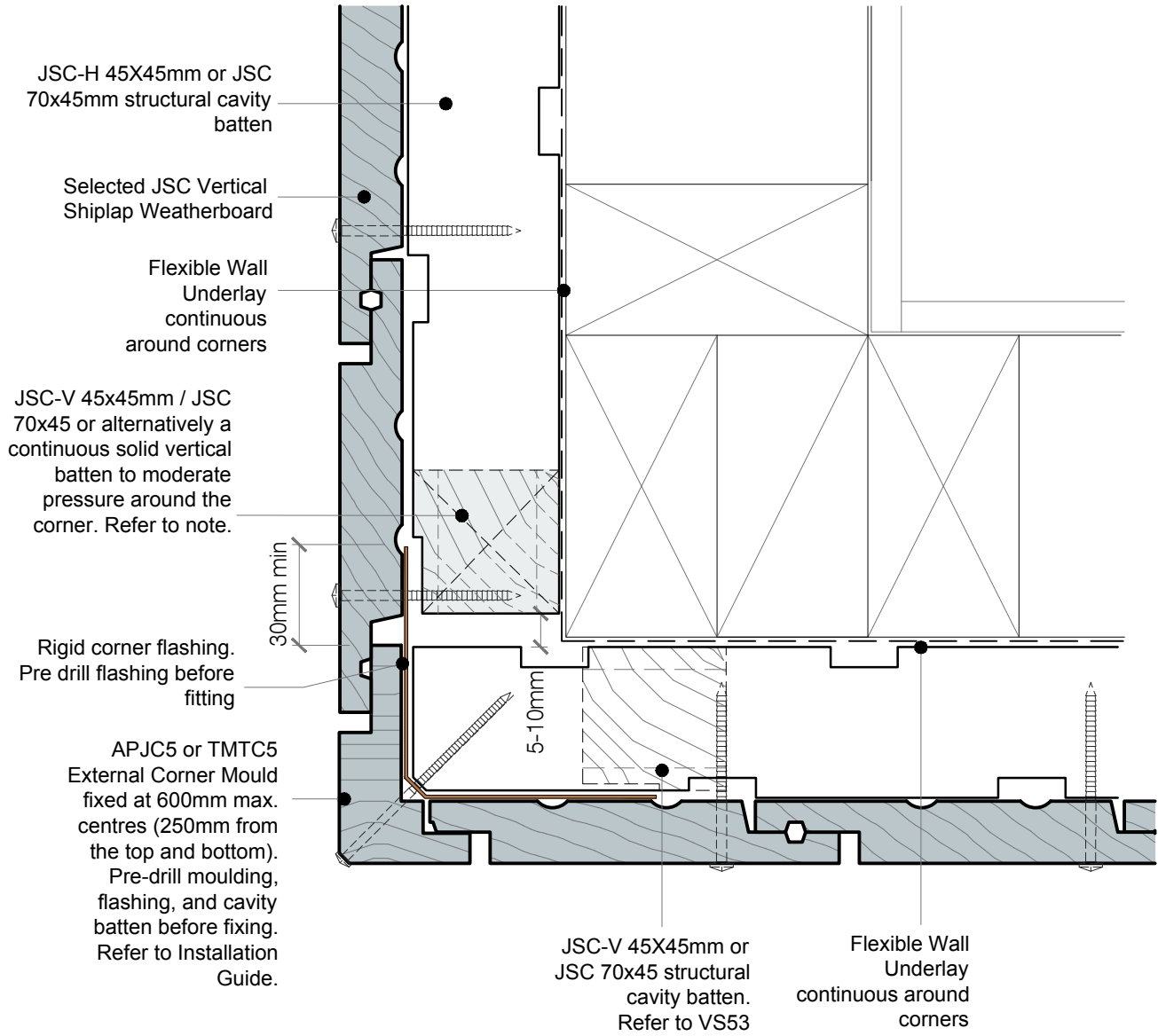

**NOTES:**

- Machine cavity battens down as required (5mm max) to accommodate corner flashing.
- For Very High (VH) and Extra High (EH) wind zones, a solid batten (non-castellated) is required down one side of a significant external corner (change in elevation) to provide pressure isolation between elevations.

• TO BE READ IN CONJUNCTION WITH COMPLETE JSC VERTICLAD SYSTEM LITERATURE

**CodeMark**  
CMNZ30084



<b>DRAWING SCALE</b> 1:2 @ A4	<b>ISSUE DATE</b> 11/02/2026
<b>DRAWING NUMBER</b> JSC 45CF VS52	<b>VERSION</b> 2.6

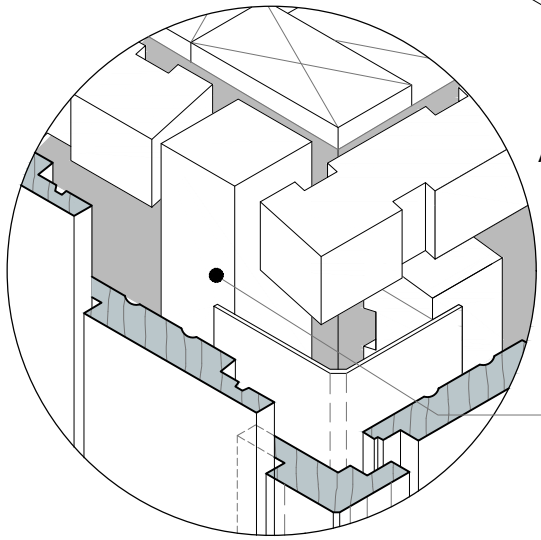
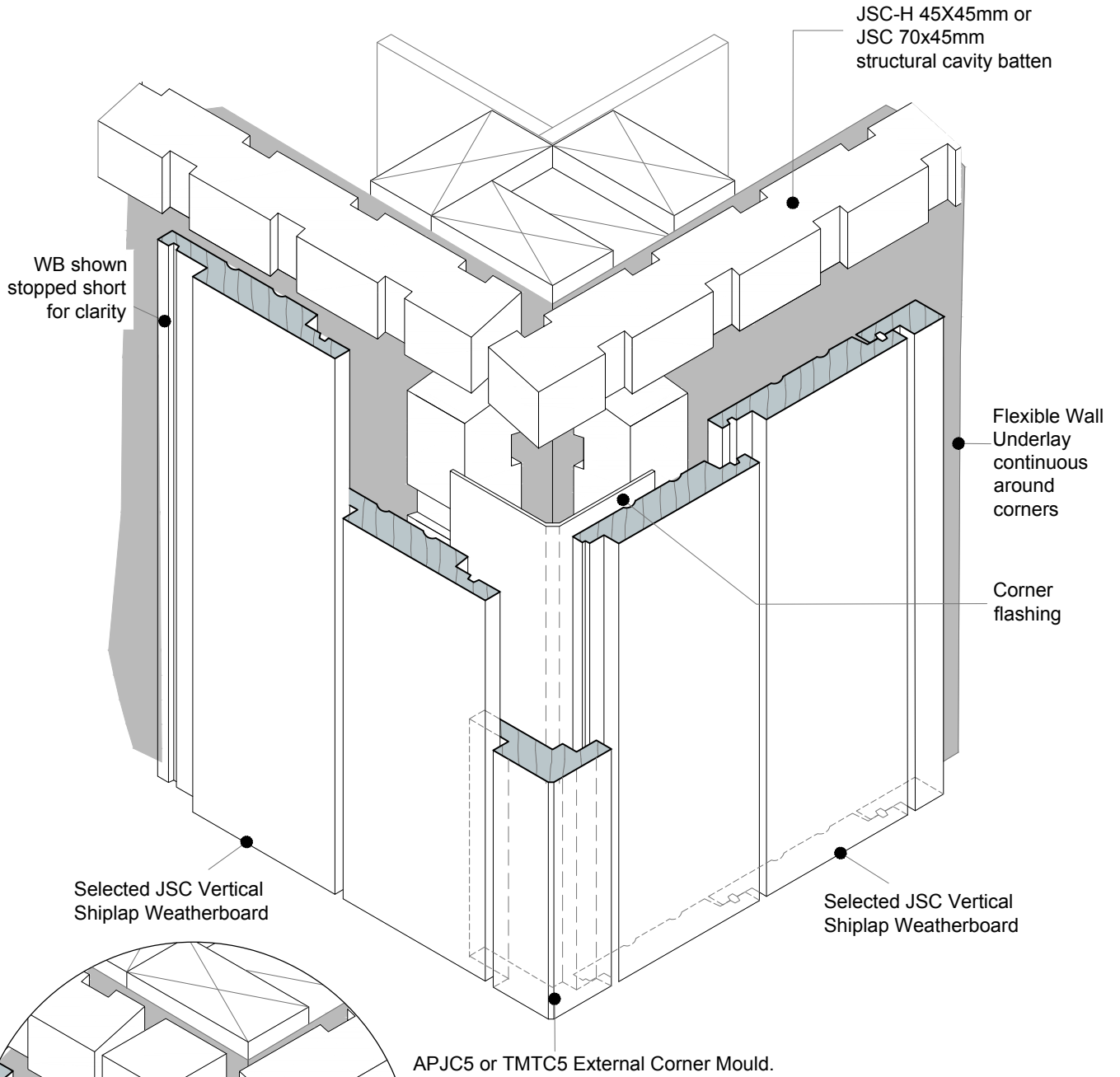

ALTERNATIVE CORNER DETAIL

• TO BE READ IN CONJUNCTION WITH COMPLETE JSC VERTICLAD SYSTEM LITERATURE

**CodeMark**  
CMNZ30084



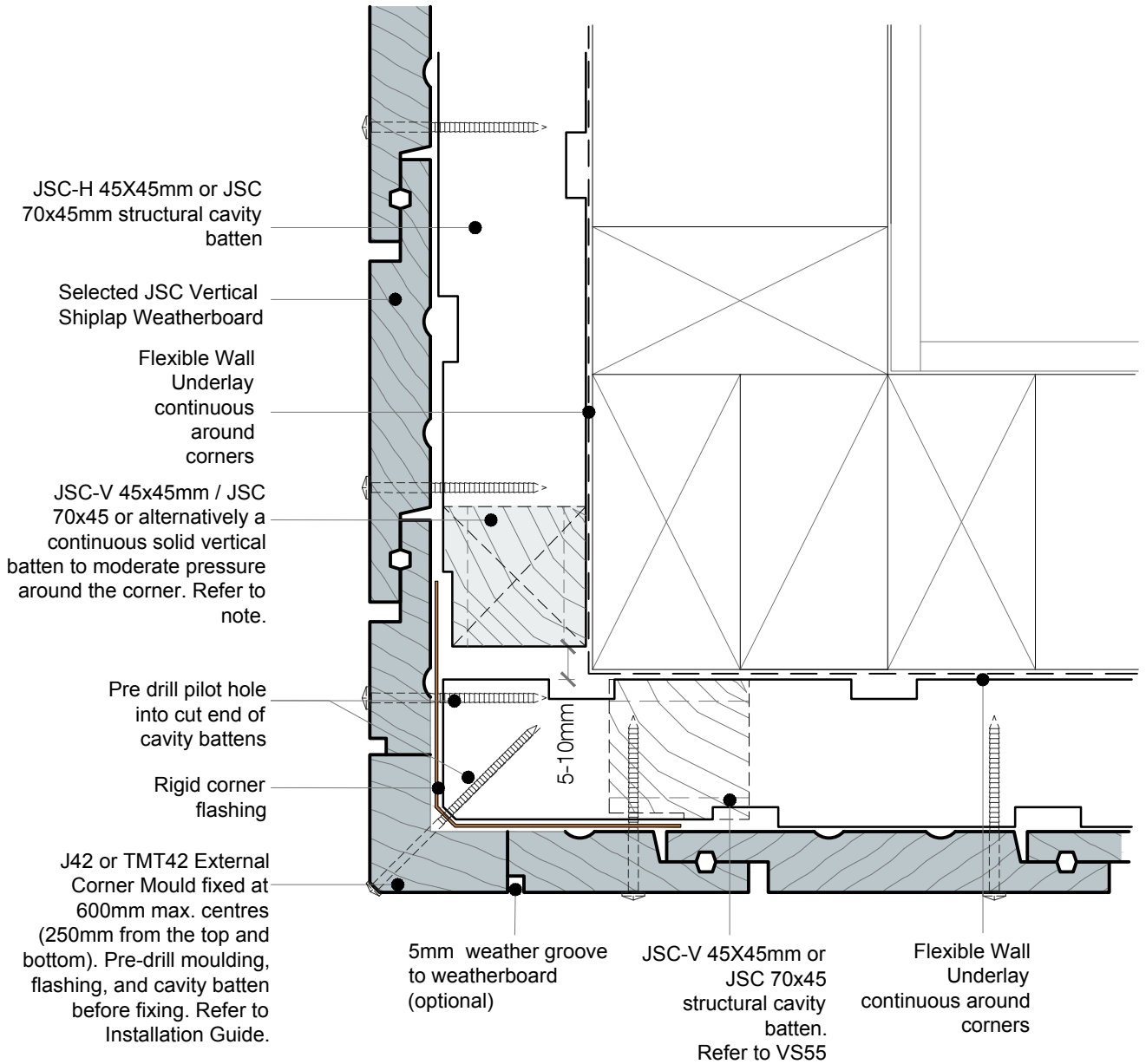

**NOTES:**

- Machine cavity battens down as required (5mm max) to accommodate corner flashing.
- For Very High (VH) and Extra High (EH) wind zones, a solid batten (non-castellated) is required down one side of a significant external corner (change in elevation) to provide pressure isolation between elevations.
- JSC recommends this detail to be used for paint finished weatherboards.
- This detail is not recommended for Pine weatherboards.

• TO BE READ IN CONJUNCTION WITH COMPLETE JSC VERTICLAD SYSTEM LITERATURE

**CodeMark**  
CMNZ30084



<b>DRAWING SCALE</b> 1:2 @ A4	<b>ISSUE DATE</b> 11/02/2026
<b>DRAWING NUMBER</b> JSC 45CF VS54	<b>VERSION</b> 2.6

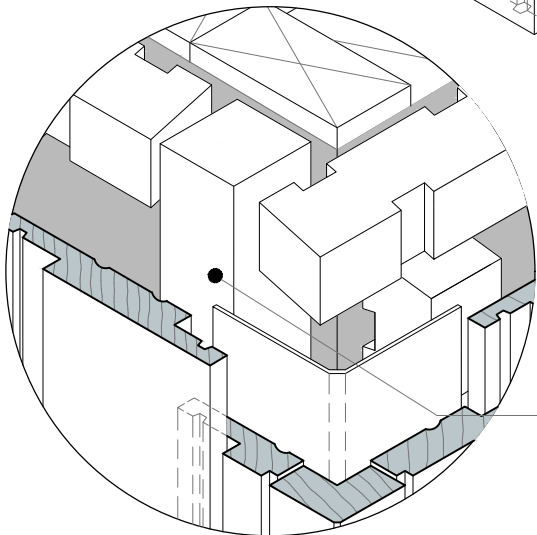
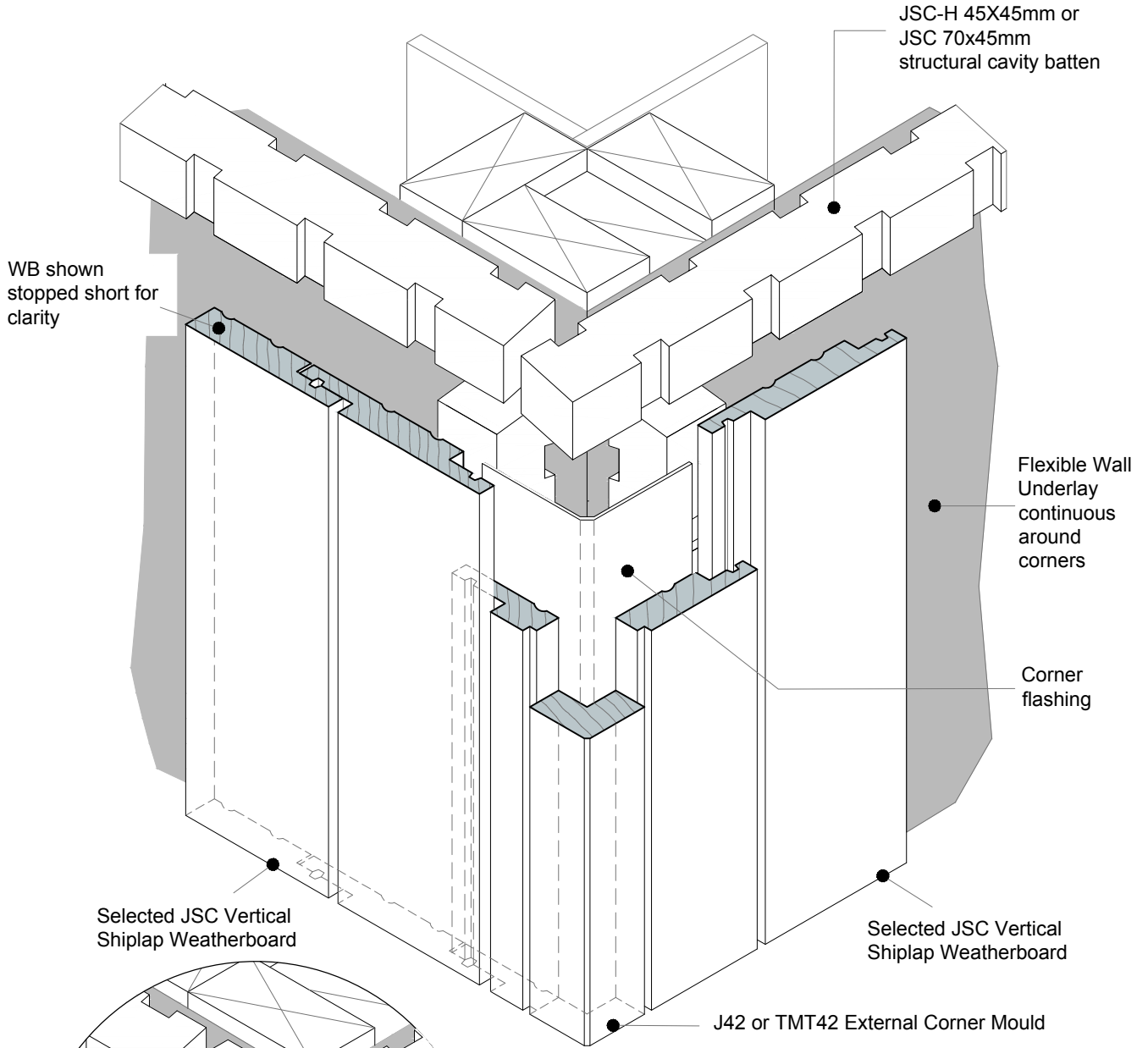

ALTERNATIVE CORNER DETAIL

NOTES:

- JSC recommends this detail to be used for paint finished weatherboards.
- This detail is not recommended for Pine weatherboards.

• TO BE READ IN CONJUNCTION WITH COMPLETE JSC VERTICLAD SYSTEM LITERATURE

CodeMark  
CMNZ30084



DRAWING SCALE N.T.S.	ISSUE DATE 11/02/2026
DRAWING NUMBER JSC 45CF VS55	VERSION 2.6

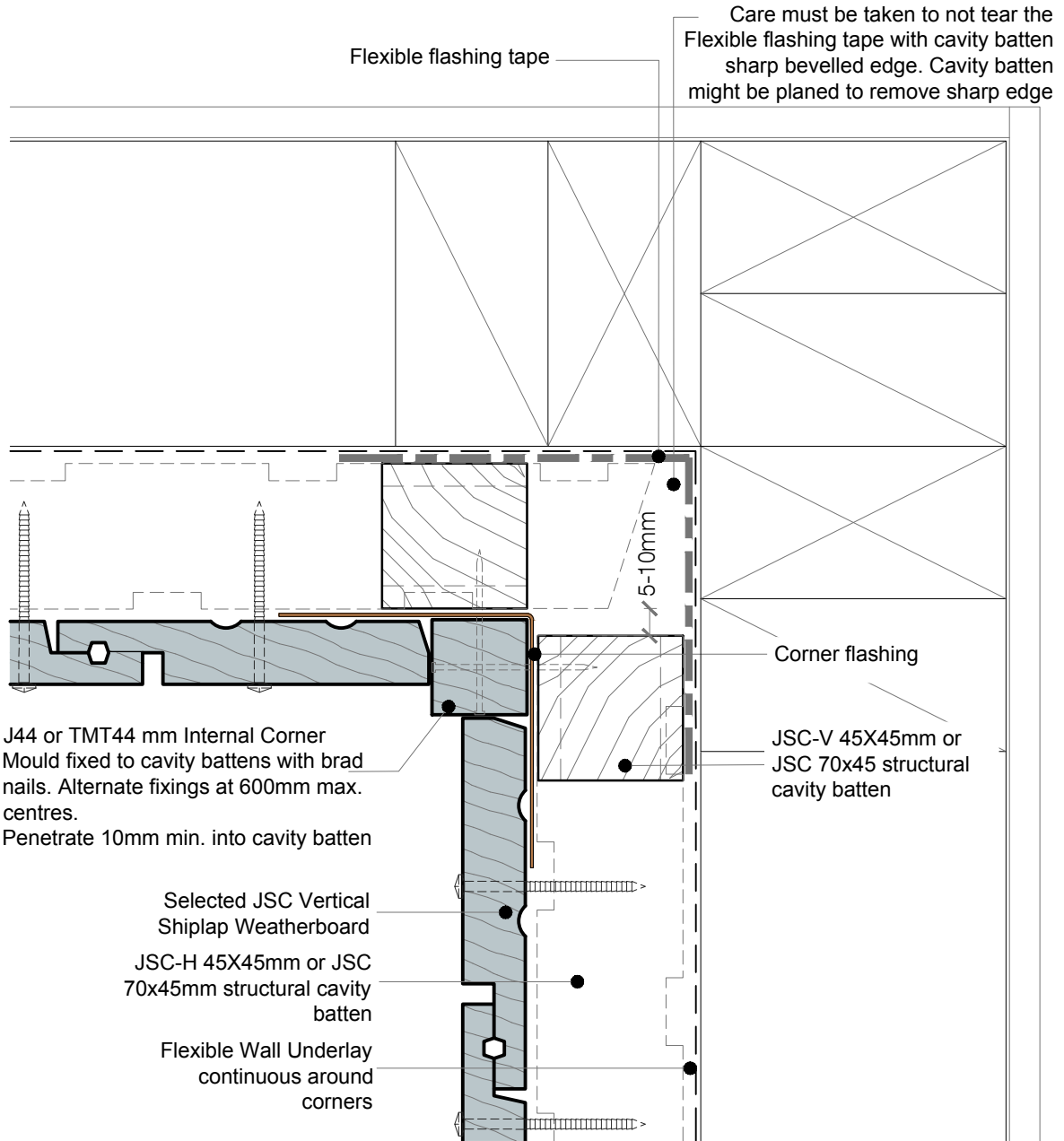

**NOTES:**

- Machine cavity battens down as required (5mm max) to accommodate corner flashing.
- Cut horizontal and vertical cavity battens on a 20-30° angle, sloping away from the framing.
- Flexible flashing tape is recommended due to movement that may occur in corners but it is not required by E2/AS1.

• TO BE READ IN CONJUNCTION WITH COMPLETE JSC VERTICLAD SYSTEM LITERATURE

**CodeMark**  
CMNZ30084



jsc.co.nz  
TechHelp@jsc.co.nz | (09) 412 2812

**TYPE**  
VERTICAL SHIPLAP WB - 45mm CAVITY FIX

**NAME**  
Internal Corner - J44

• DETAILS MAY BE SUBJECT TO CHANGE WITHOUT NOTICE



SCAN IT FOR MORE INFORMATION

<b>DRAWING SCALE</b> 1:2 @ A4	<b>ISSUE DATE</b> 11/02/2026
<b>DRAWING NUMBER</b> JSC 45CF VS60	<b>VERSION</b> 2.6

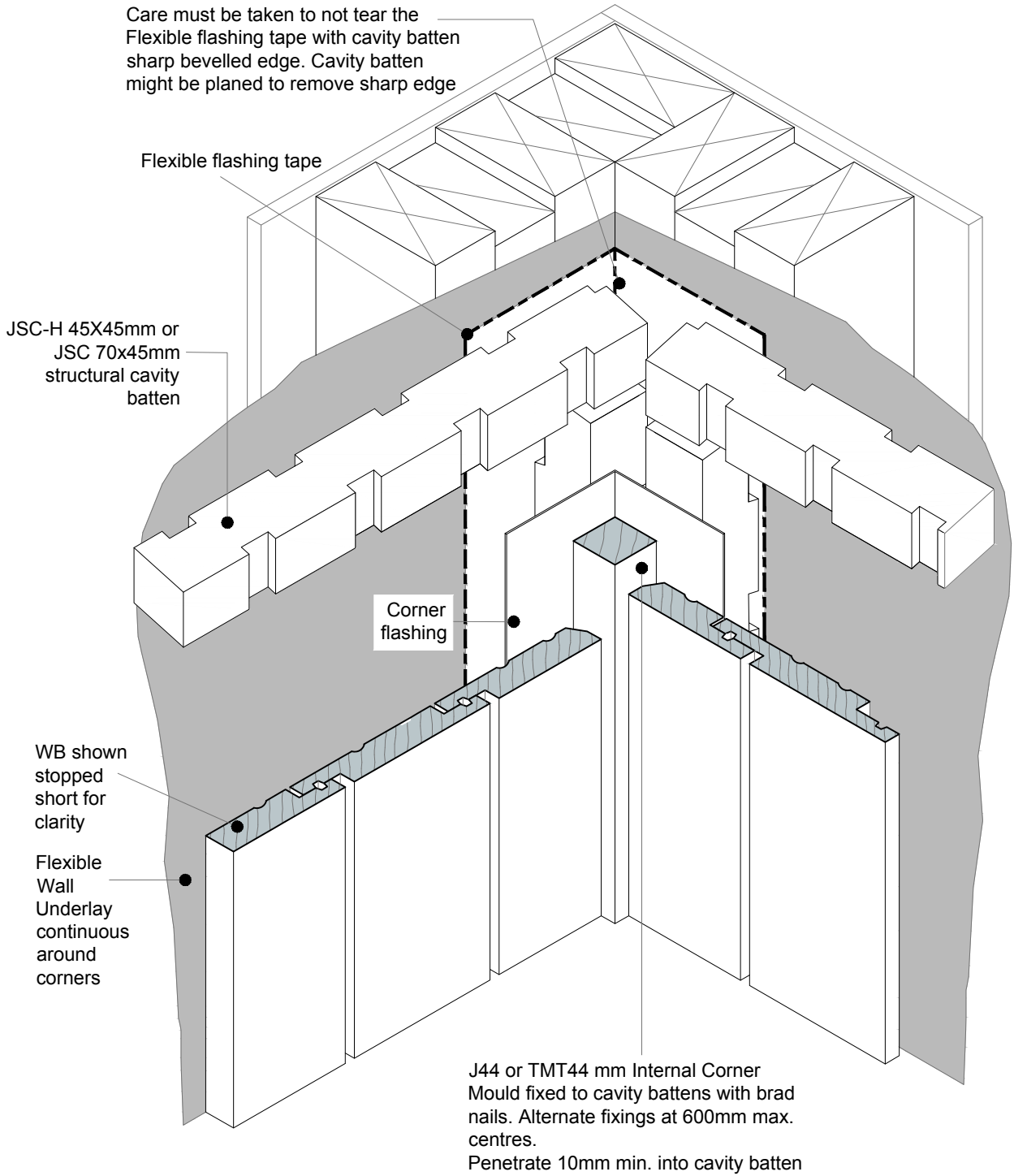

• TO BE READ IN CONJUNCTION WITH COMPLETE JSC VERTICLAD SYSTEM LITERATURE

**CodeMark**  
CMNZ30084



SCAN IT FOR MORE INFORMATION

<b>DRAWING SCALE</b> N.T.S.	<b>ISSUE DATE</b> 11/02/2026
<b>DRAWING NUMBER</b> JSC 45CF VS61	<b>VERSION</b> 2.6

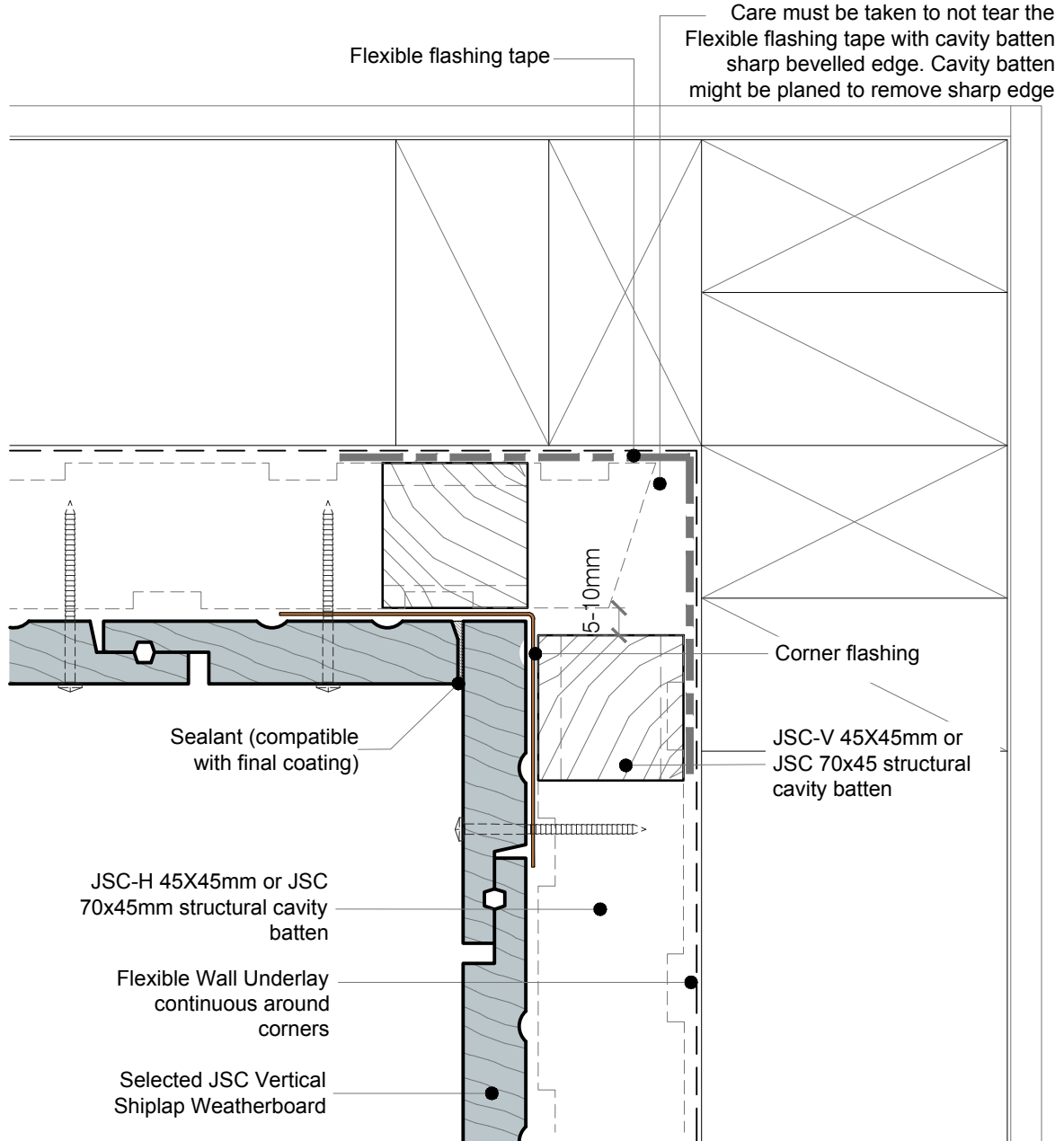

**NOTES:**

- Machine cavity battens down as required (5mm max) to accommodate corner flashing.
- Cut horizontal and vertical cavity battens on a 20-30° angle, sloping away from the framing.
- Flexible flashing tape is recommended due to movement that may occur in corners but it is not required by E2/AS1.

• TO BE READ IN CONJUNCTION WITH COMPLETE JSC VERTICLAD SYSTEM LITERATURE

**CodeMark**  
CMNZ30084



jsc.co.nz  
TechHelp@jsc.co.nz | (09) 412 2812

**TYPE**  
VERTICAL SHIPLAP WB - 45mm CAVITY FIX

**NAME**  
Internal Corner

• DETAILS MAY BE SUBJECT TO CHANGE WITHOUT NOTICE



SCAN IT FOR MORE INFORMATION

<b>DRAWING SCALE</b> 1:2 @ A4	<b>ISSUE DATE</b> 11/02/2026
----------------------------------	---------------------------------

<b>DRAWING NUMBER</b> JSC 45CF VS62	<b>VERSION</b> 2.6
--	-----------------------

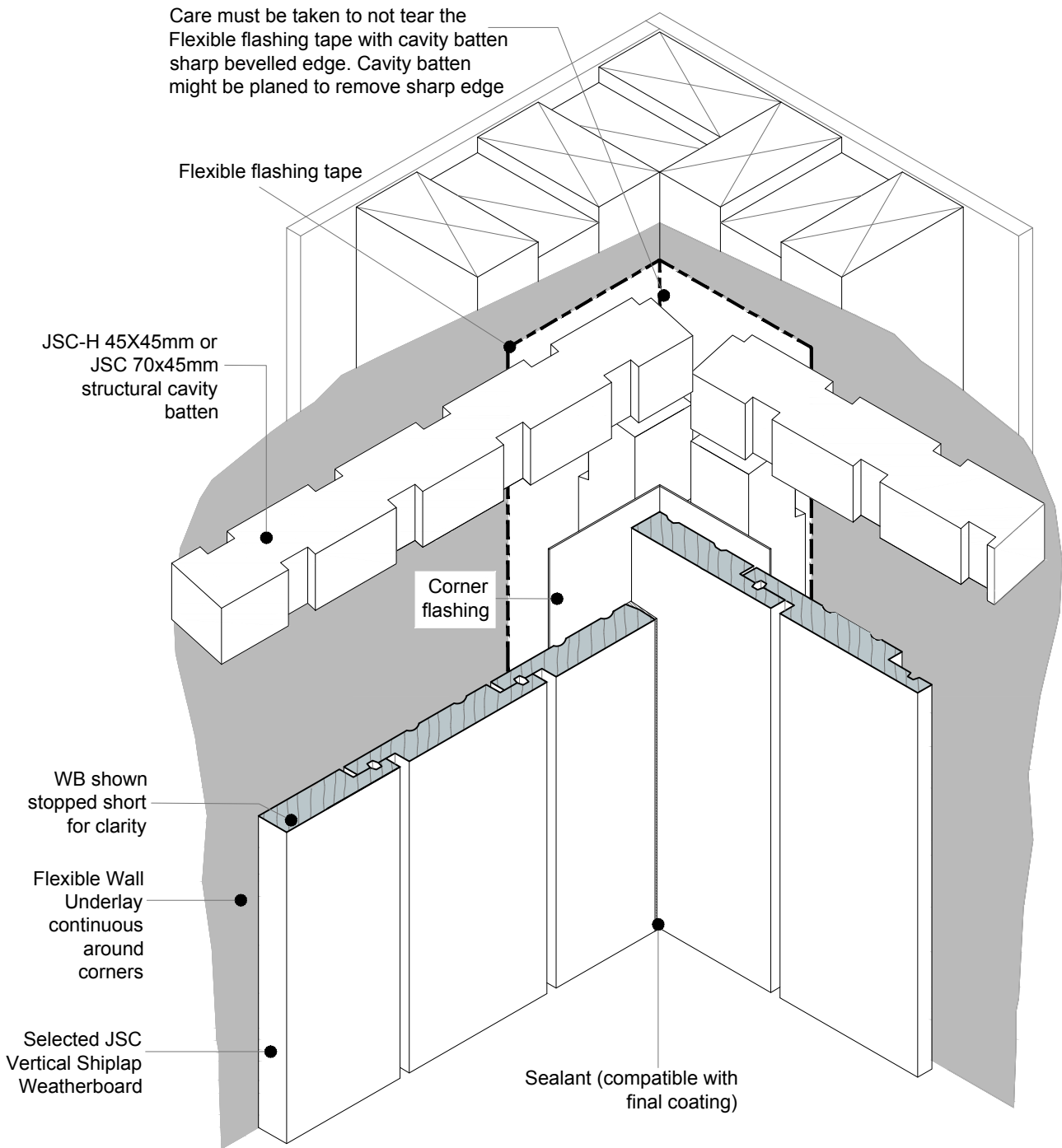

• TO BE READ IN CONJUNCTION WITH COMPLETE JSC VERTICLAD SYSTEM LITERATURE

**CodeMark**  
CMNZ30084



<b>DRAWING SCALE</b> N.T.S.	<b>ISSUE DATE</b> 11/02/2026
<b>DRAWING NUMBER</b> JSC 45CF VS63	<b>VERSION</b> 2.6

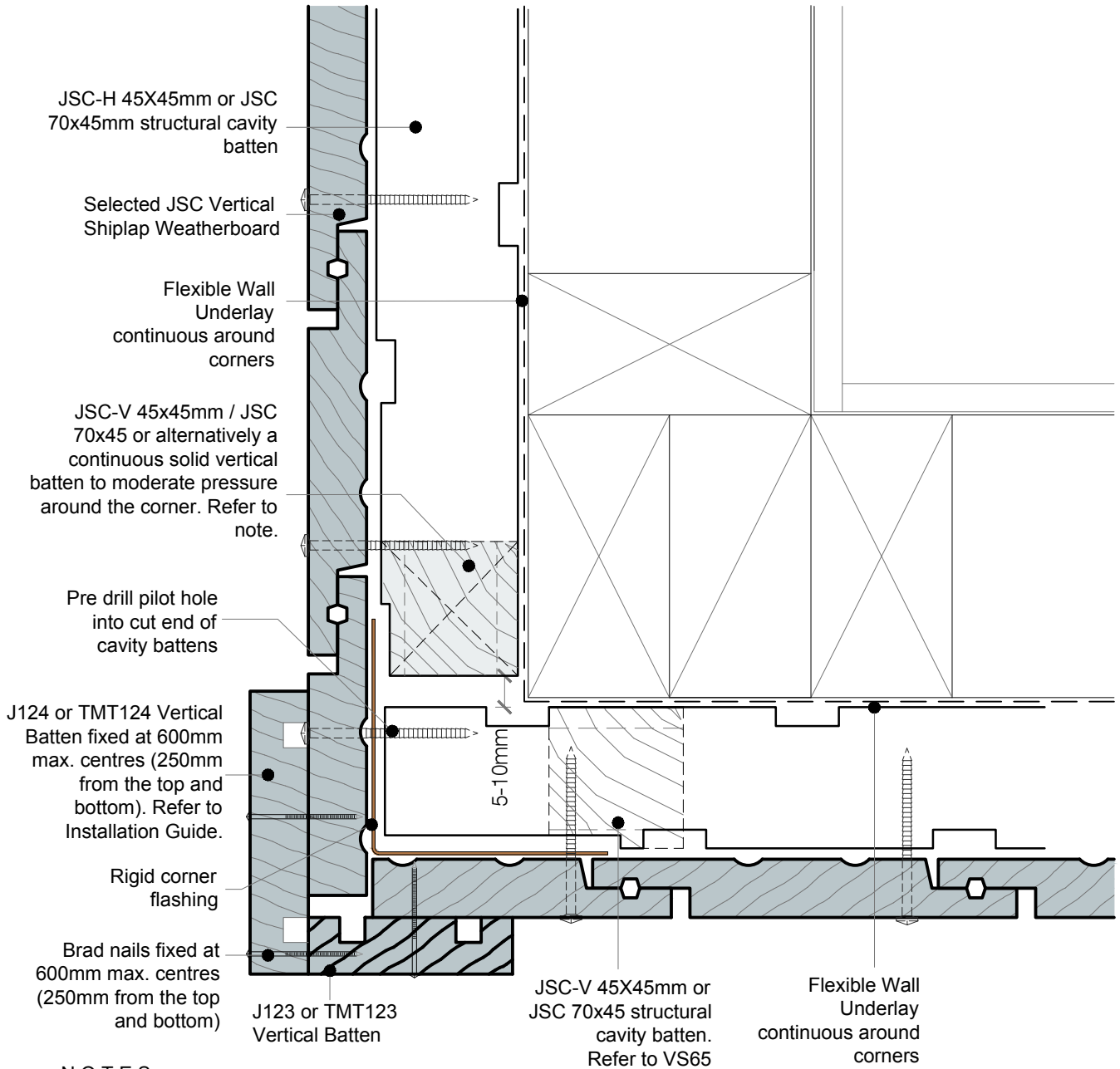

**NOTES:**

- Machine cavity battens down as required (5mm max) to accommodate corner flashing.
- For Very High (VH) and Extra High (EH) wind zones, a solid batten (non-castellated) is required down one side of a significant external corner (change in elevation) to provide pressure isolation between elevations.
- JSC recommends this detail to be used for paint finished weatherboards.
- JSC recommends this detail to be used for pine weatherboards.

• TO BE READ IN CONJUNCTION WITH COMPLETE JSC VERTICLAD SYSTEM LITERATURE

**CodeMark**  
CMNZ30084



jsc.co.nz  
TechHelp@jsc.co.nz | (09) 412 2812

**TYPE**  
VERTICAL SHIPLAP WB - 45mm CAVITY FIX

**NAME**  
External Corner - Box Corner

• DETAILS MAY BE SUBJECT TO CHANGE WITHOUT NOTICE



SCAN IT FOR MORE INFORMATION

<b>DRAWING SCALE</b> N.T.S.	<b>ISSUE DATE</b> 11/02/2026
<b>DRAWING NUMBER</b> JSC 45CF VS64	<b>VERSION</b> 2.6

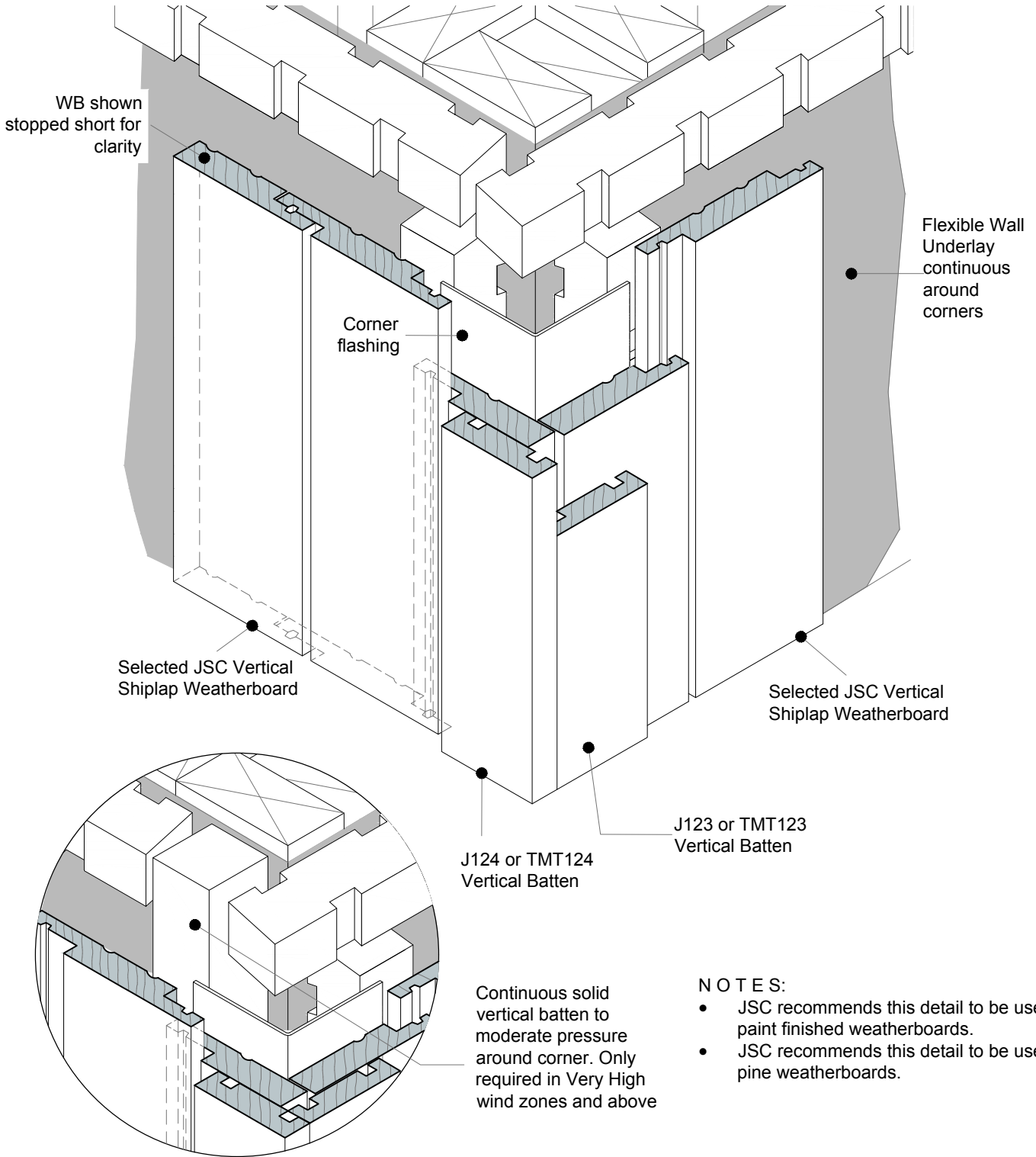

NOTES:

- JSC recommends this detail to be used for paint finished weatherboards.
- JSC recommends this detail to be used for pine weatherboards.

• TO BE READ IN CONJUNCTION WITH COMPLETE JSC VERTICLAD SYSTEM LITERATURE

**CodeMark**  
CMNZ30084



DRAWING SCALE N.T.S.	ISSUE DATE 11/02/2026
DRAWING NUMBER JSC 45CF VS65	VERSION 2.6

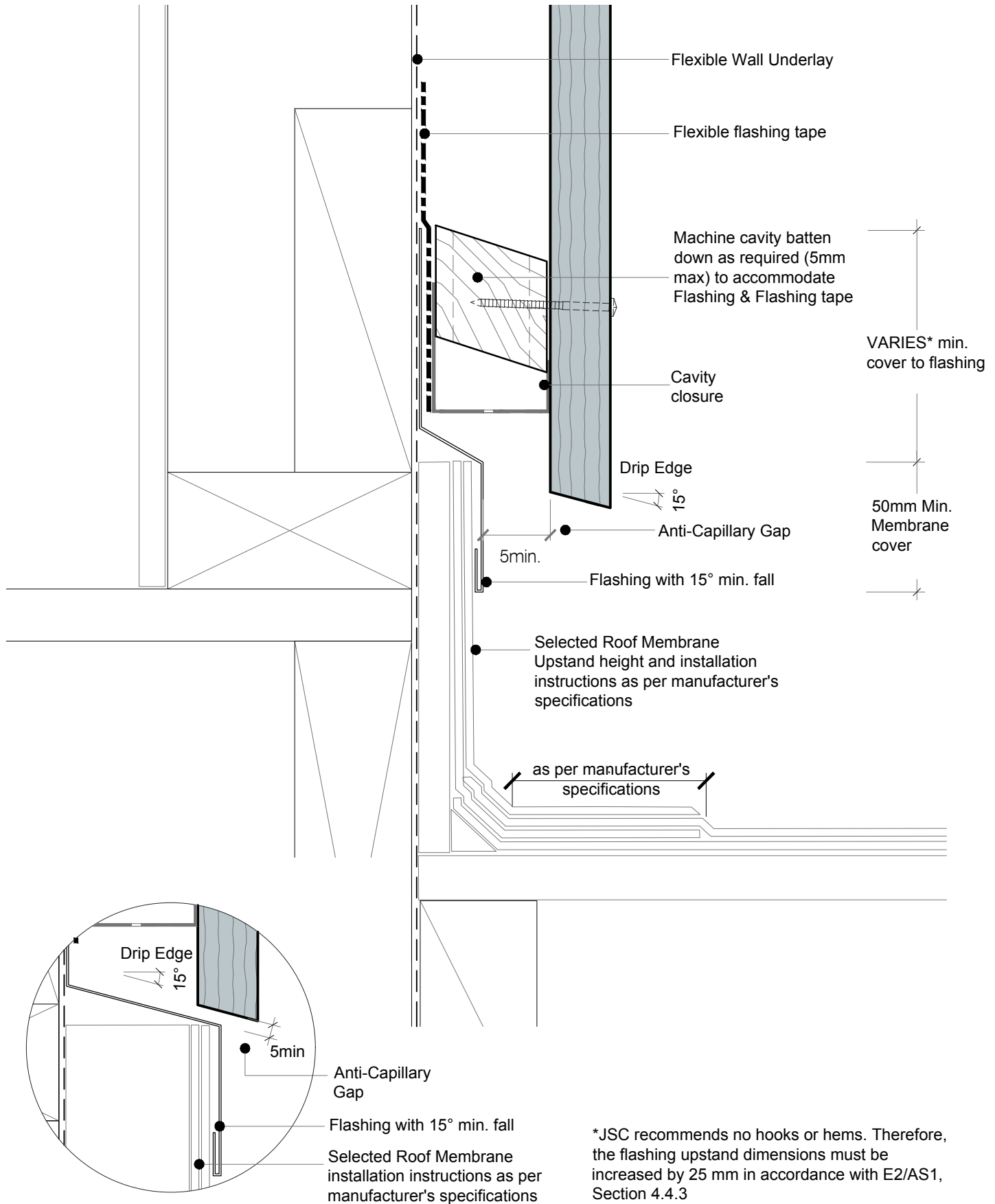

• TO BE READ IN CONJUNCTION WITH COMPLETE JSC VERTICLAD SYSTEM LITERATURE

**CodeMark**  
CMNZ30084



SEQUENCE :

1. Framing
2. Wall Underlay
3. Parapet Cavity battens
4. Packer to form slope
5. Flexible Flashing tape

DETAIL NOTE :

REFER TO E2/AS1 FIGURE 6.2.3.1B FOR SADDLE FLASHING DIMENSIONS

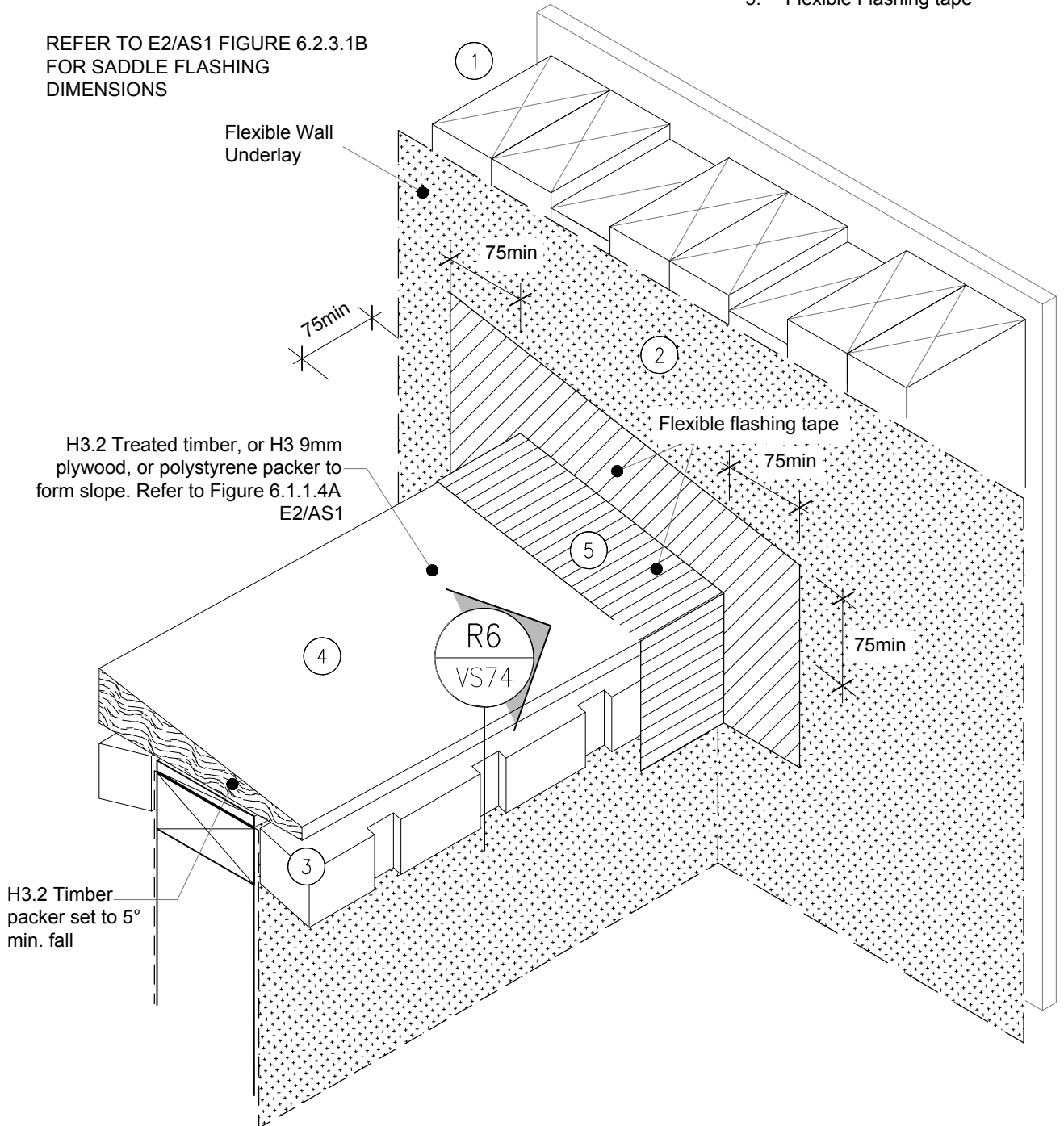

• TO BE READ IN CONJUNCTION WITH COMPLETE JSC VERTICLAD SYSTEM LITERATURE

**CodeMark**  
CMNZ30084



jsc.co.nz  
TechHelp@jsc.co.nz | (09) 412 2812

**TYPE**  
VERTICAL SHIPLAP WB - 45mm CAVITY FIX

**NAME**  
Parapet Saddle Flashing - Stage One

• DETAILS MAY BE SUBJECT TO CHANGE WITHOUT NOTICE



SCAN IT FOR MORE INFORMATION

<b>DRAWING SCALE</b> NTS	<b>ISSUE DATE</b> 11/02/2026
<b>DRAWING NUMBER</b> JSC 45CF VS71a	<b>VERSION</b> 2.6

SEQUENCE :

1. Framing
2. Wall Underlay
3. Parapet Cavity battens
4. Packer to form slope
5. Flexible Flashing tape
6. Cavity battens on wall
7. Corner flashings

DETAIL NOTE :

REFER TO E2/AS1 FIGURE 6.2.3.1B FOR SADDLE FLASHING DIMENSIONS

Care must be taken to not tear the Flexible Wall Underlay with cavity batten sharp bevelled edge. Cavity batten might be planed to remove sharp edge

H3.2 Treated timber, or H3 9mm plywood, or polystyrene packer to form slope. Refer to Figure 6.1.1.4A E2/AS1

H3.2 Timber packer set to 5° min. fall

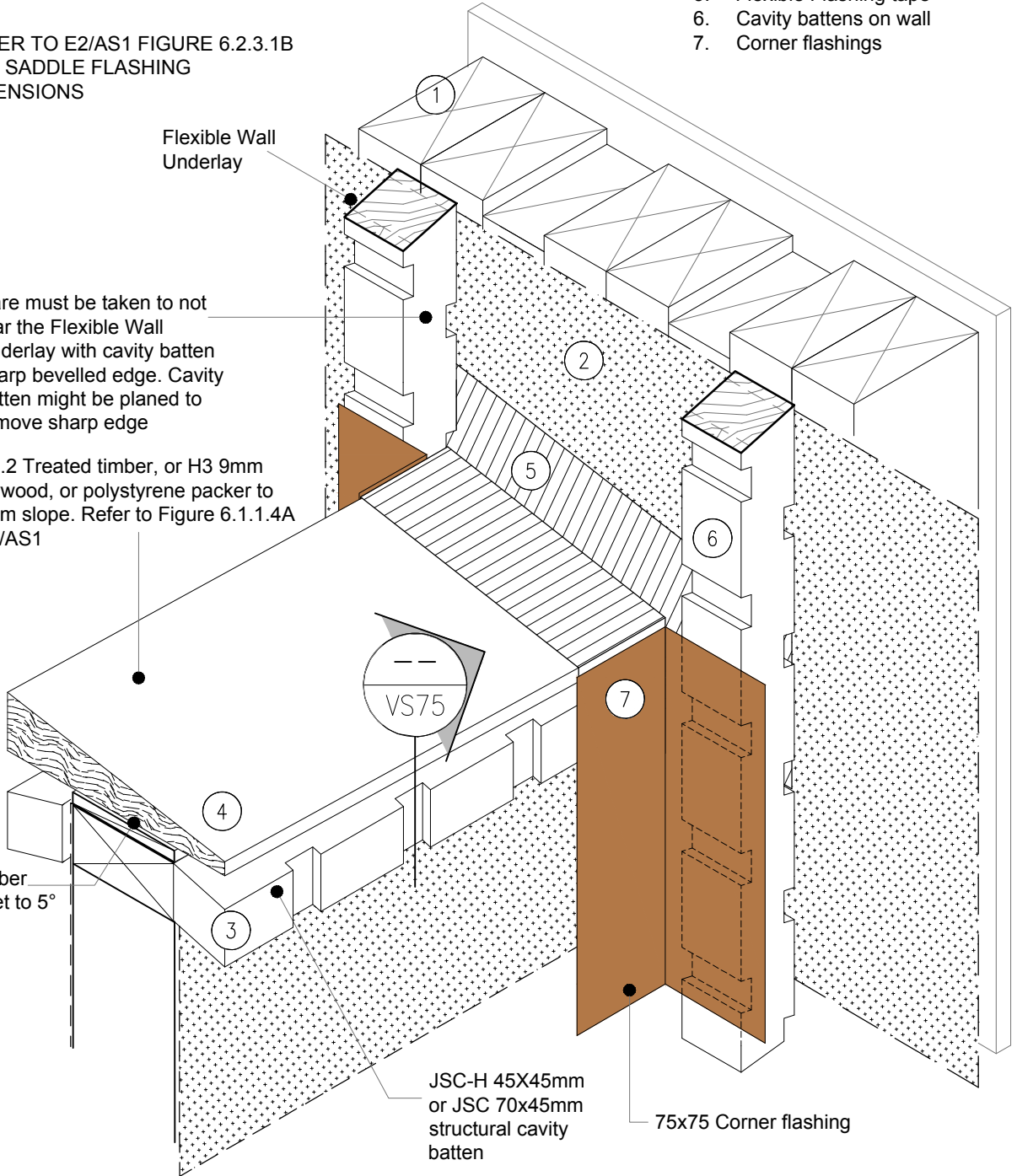

• TO BE READ IN CONJUNCTION WITH COMPLETE JSC VERTICLAD SYSTEM LITERATURE

**CodeMark**  
CMNZ30084



DRAWING SCALE NTS	ISSUE DATE 11/02/2026
DRAWING NUMBER JSC 45CF VS71b	VERSION 2.6

**DETAIL NOTE :**

REFER TO E2/AS1 FIGURE 6.2.3.1B  
FOR SADDLE FLASHING  
DIMENSIONS

**SEQUENCE :**

- 8. Cladding
- 9. Separation layer
- 10. Saddle Flashing

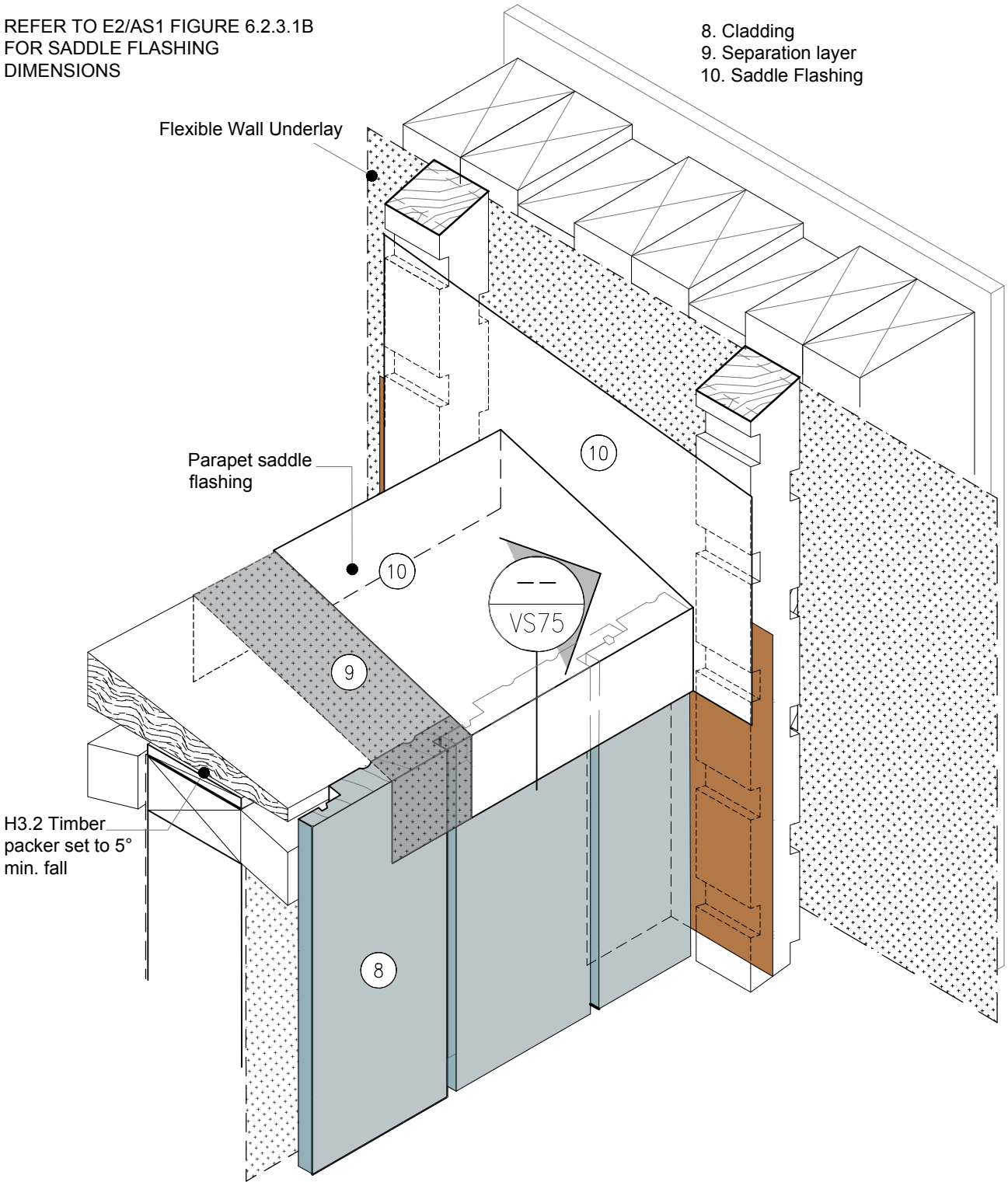

• TO BE READ IN CONJUNCTION WITH COMPLETE JSC VERTICLAD SYSTEM LITERATURE

**CodeMark**  
CMNZ30084



<b>DRAWING SCALE</b> NTS	<b>ISSUE DATE</b> 11/02/2026
<b>DRAWING NUMBER</b> JSC 45CF VS71c	<b>VERSION</b> 2.6

**DETAIL NOTE :**

REFER TO E2/AS1 FIGURE 6.2.3.1B FOR SADDLE FLASHING DIMENSIONS

**SEQUENCE :**

- 11. Cladding over saddle flashing
- 12. Cap flashing

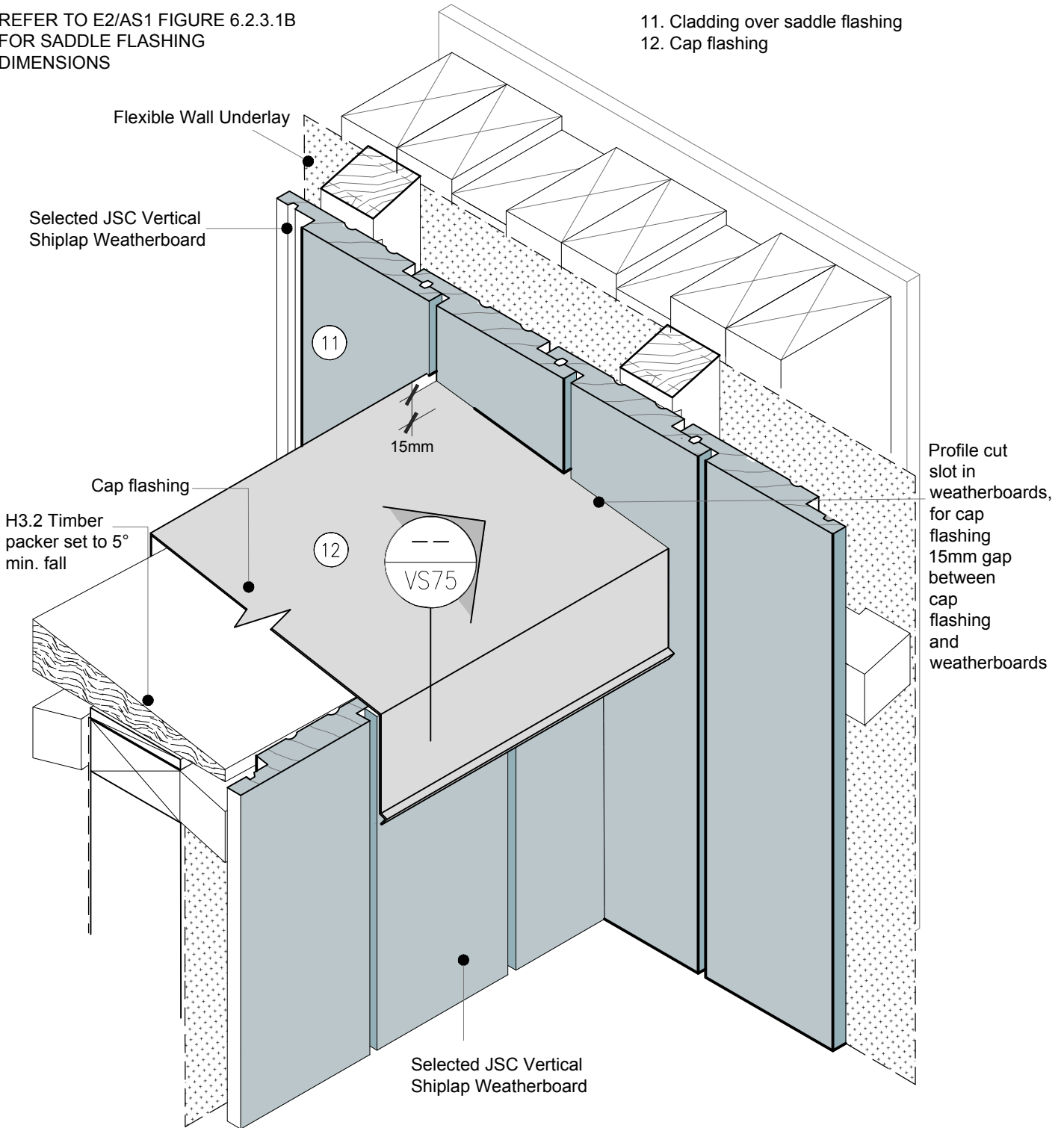

• TO BE READ IN CONJUNCTION WITH COMPLETE JSC VERTICLAD SYSTEM LITERATURE

**CodeMark**  
CMNZ30084



jsc.co.nz  
TechHelp@jsc.co.nz | (09) 412 2812

**TYPE**  
VERTICAL SHIPLAP WB - 45mm CAVITY FIX

**NAME**  
Parapet Saddle Flashing - Stage Four

• DETAILS MAY BE SUBJECT TO CHANGE WITHOUT NOTICE



SCAN IT FOR MORE INFORMATION

<b>DRAWING SCALE</b> NTS	<b>ISSUE DATE</b> 11/02/2026
<b>DRAWING NUMBER</b> JSC 45CF VS71d	<b>VERSION</b> 2.6

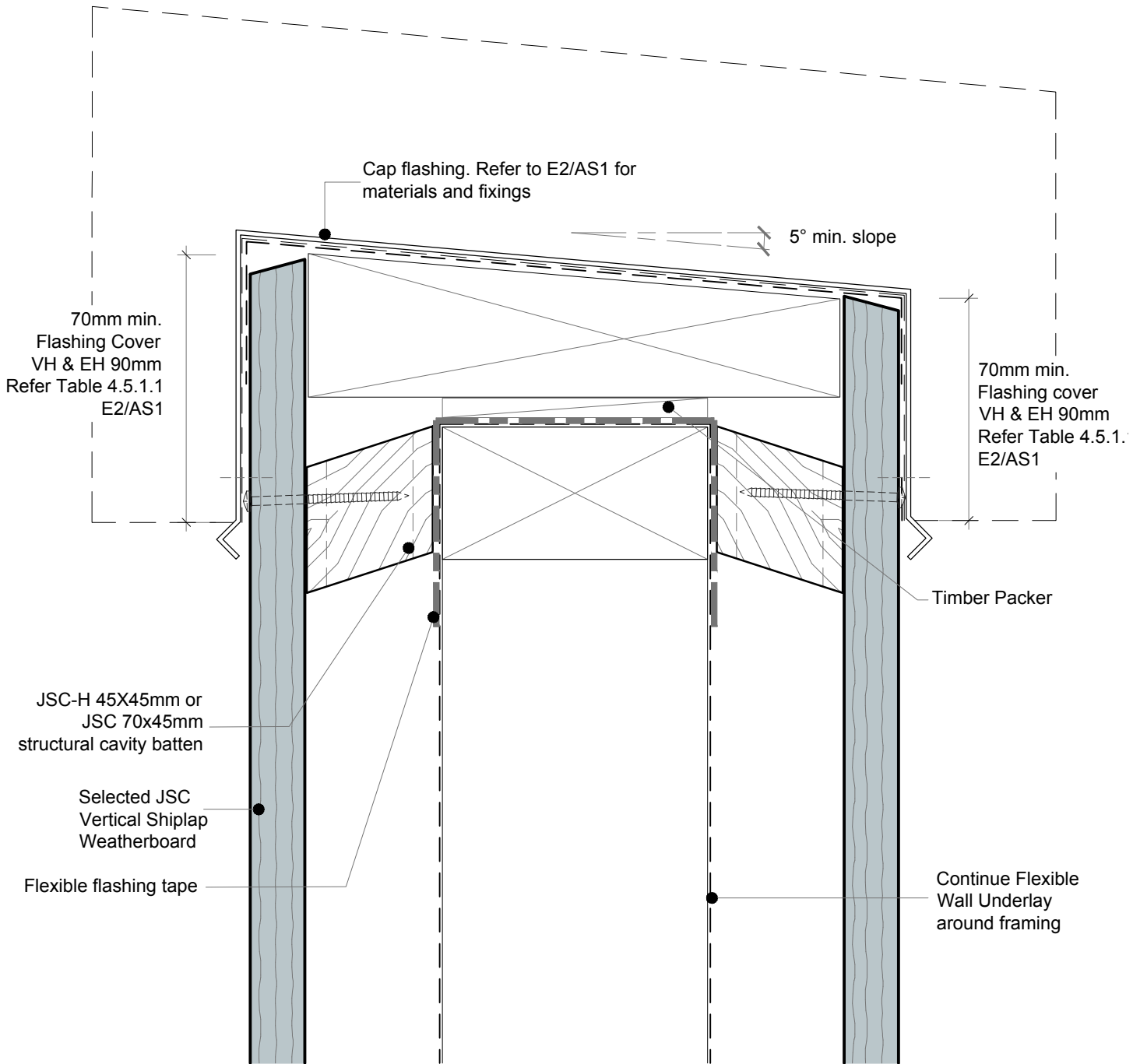

• TO BE READ IN CONJUNCTION WITH COMPLETE JSC VERTICLAD SYSTEM LITERATURE

**CodeMark**  
CMNZ30084



<b>DRAWING SCALE</b> NTS	<b>ISSUE DATE</b> 11/02/2026
<b>DRAWING NUMBER</b> JSC 45CF VS75	<b>VERSION</b> 2.6

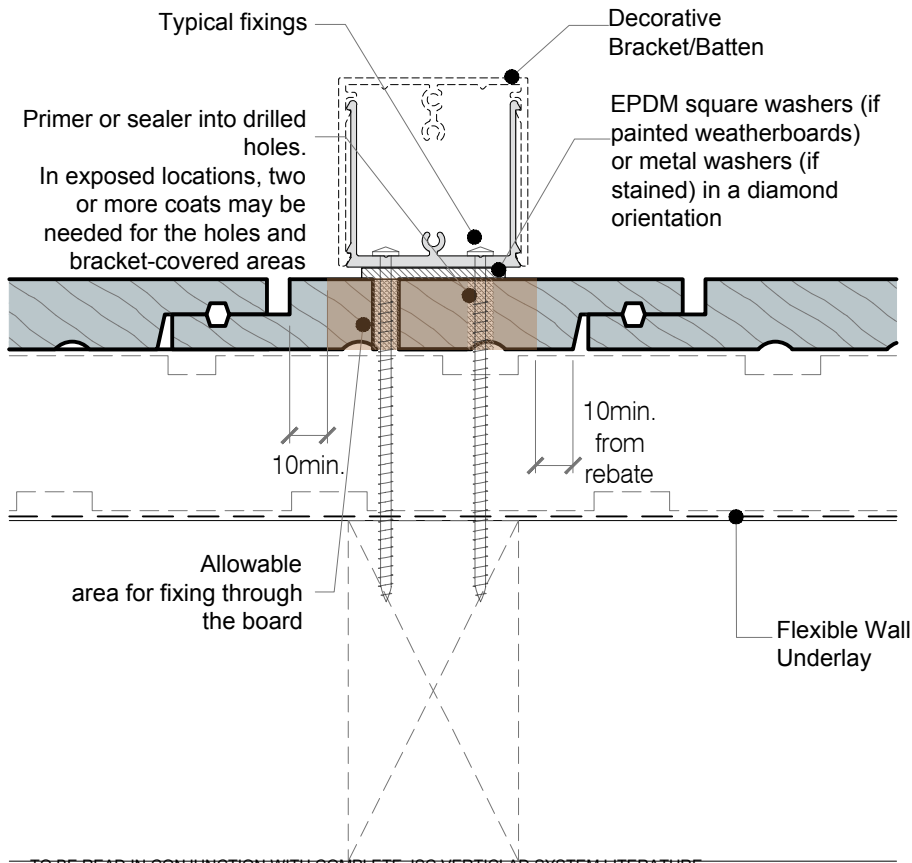
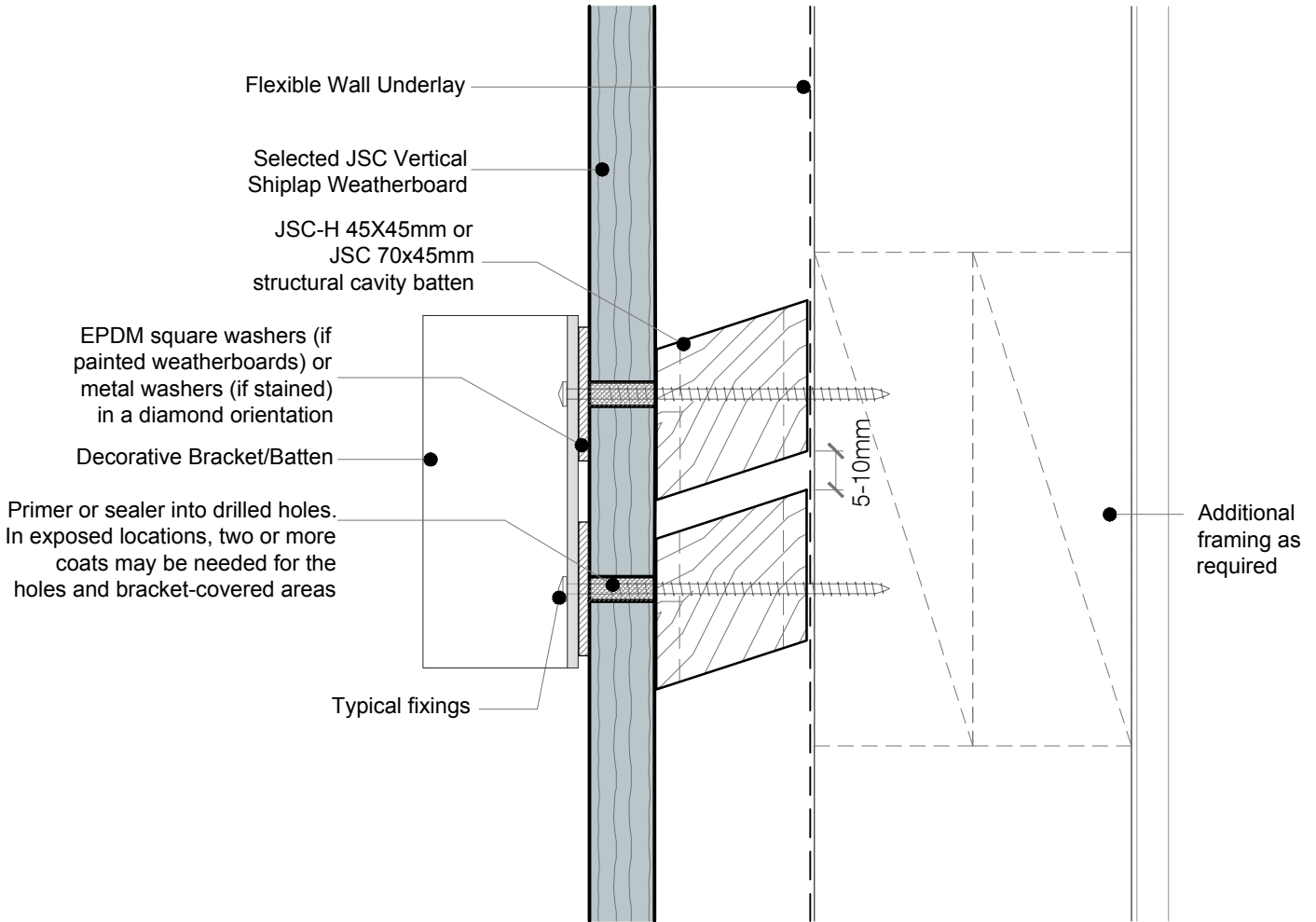

**NOTES:**

- This detail is to show penetration through the cladding. Framing structure and fixings as per NZS3604:2011 or Specific engineered design.
- Refer to this detail as a principle rather than specific instruction.
- Durable and compatible materials, in accordance with the material selection and compatibility tables in Appendix C of E2/AS1 Fourth Edition.
- If bracket fixings interfere with weatherboard laps, consider an alternative, such as an offset bracket.
- Fixings should be sufficient for the load, with this detail intended for low to medium forces (decorative batten)

Any penetration or contact with the cladding should:

- Be coated for water resistance (e.g., two coats of stain).
- Be inspectable; avoid hidden high-risk penetrations.
- Be maintainable; brackets should be removable for inspection or treatment of weatherboards.

• TO BE READ IN CONJUNCTION WITH COMPLETE JSC VERTICLAD SYSTEM LITERATURE

**CodeMark**  
CMNZ30084



DRAWING SCALE NTS	ISSUE DATE 11/02/2026
DRAWING NUMBER JSC 45CF VS77	VERSION 2.6

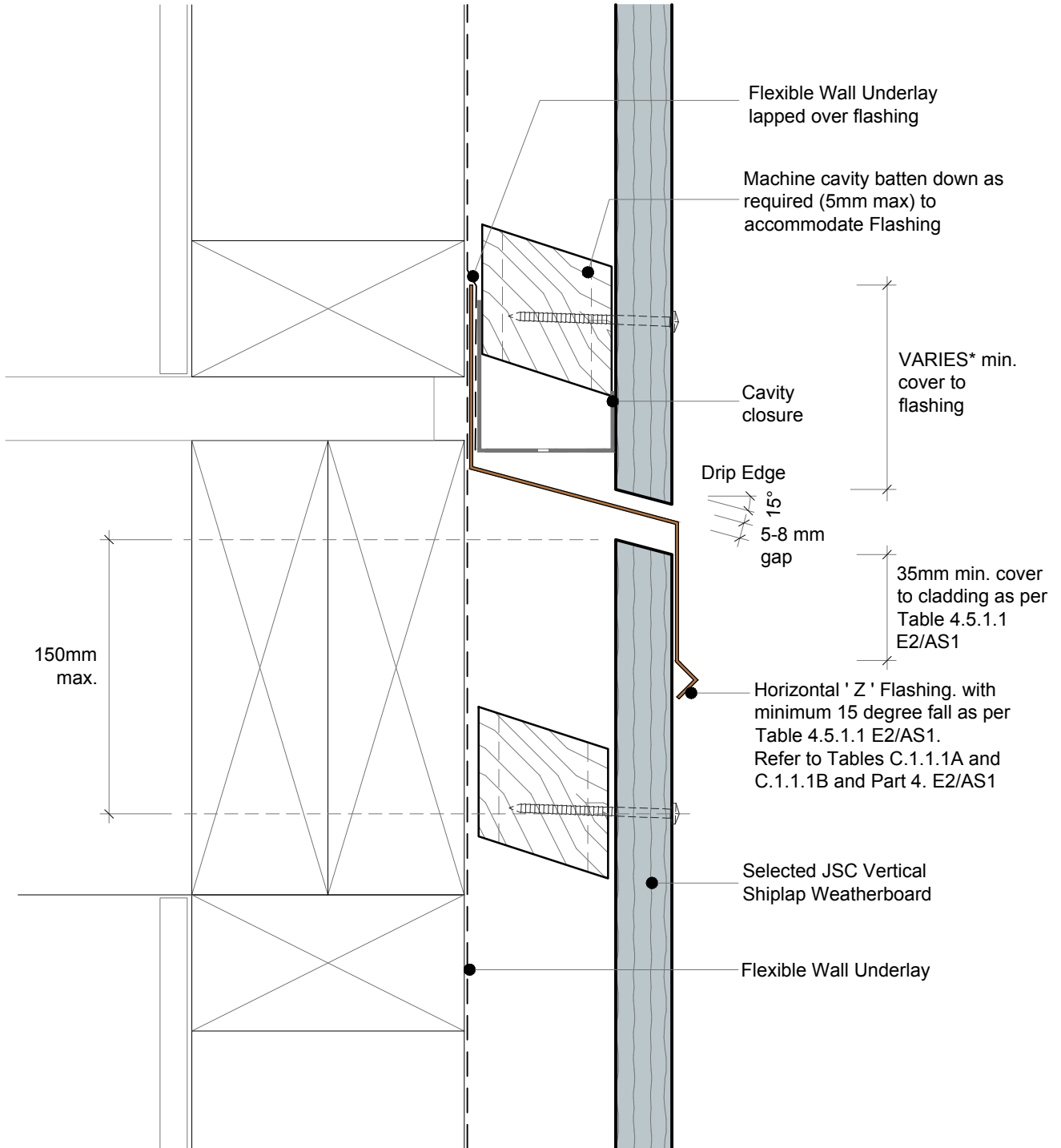

\*JSC recommends no hooks or hems. Therefore, the flashing upstand dimensions must be increased by 25 mm in accordance with E2/AS1, Section 4.4.3

• TO BE READ IN CONJUNCTION WITH COMPLETE JSC VERTICLAD SYSTEM LITERATURE

**CodeMark**  
CMNZ30084

**JSC** PREMIUM ARCHITECTURAL & BUILDING SOLUTIONS

jsc.co.nz  
TechHelp@jsc.co.nz | (09) 412 2812

**TYPE**  
VERTICAL SHIPLAP WB - 45mm CAVITY FIX

**NAME**  
Inter Storey Joint

• DETAILS MAY BE SUBJECT TO CHANGE WITHOUT NOTICE



SCAN IT FOR MORE INFORMATION

<b>DRAWING SCALE</b> 1:2 @ A4	<b>ISSUE DATE</b> 11/02/2026
----------------------------------	---------------------------------

<b>DRAWING NUMBER</b> JSC 45CF VS80	<b>VERSION</b> 2.6
--	-----------------------

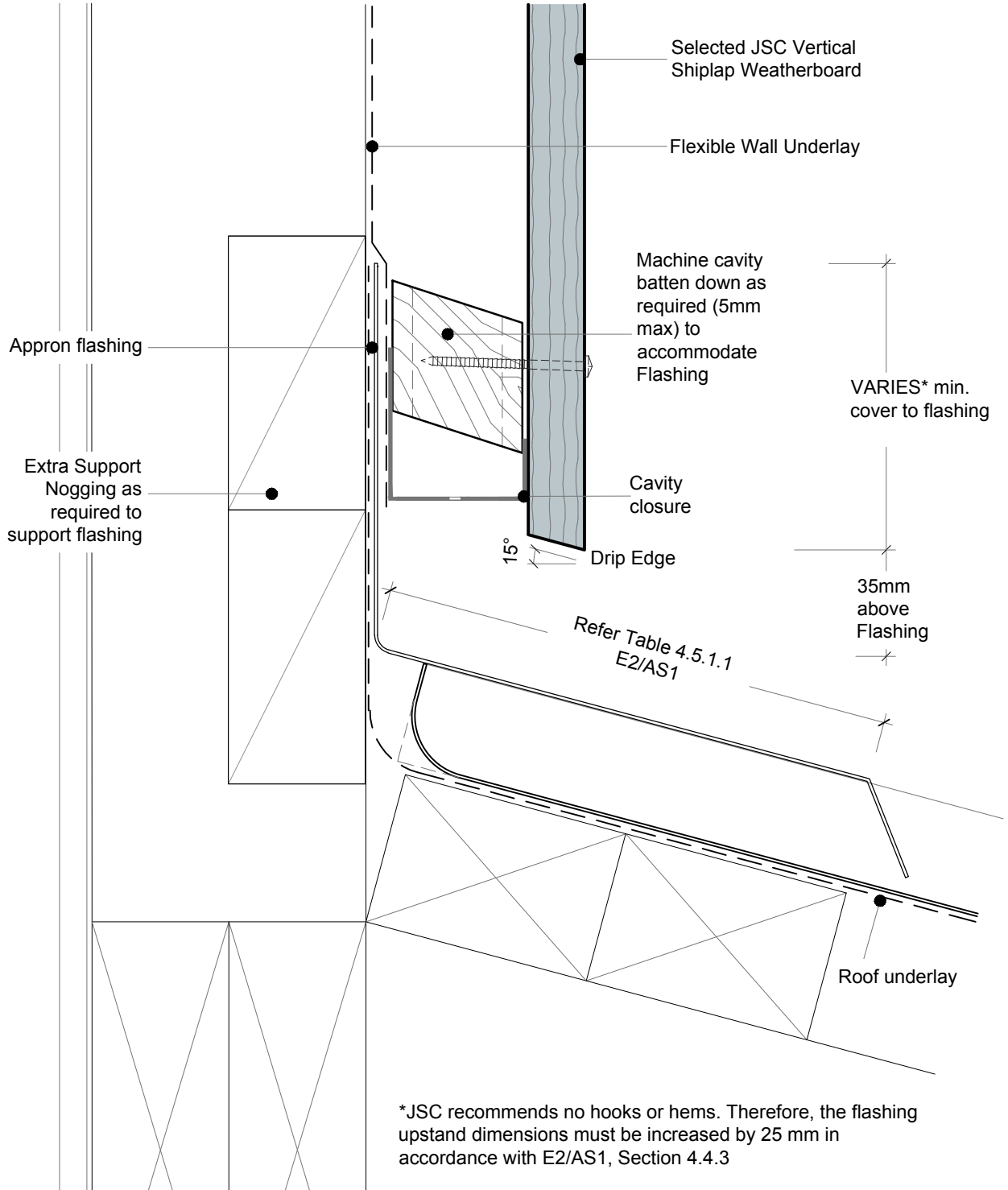

• TO BE READ IN CONJUNCTION WITH COMPLETE JSC VERTICLAD SYSTEM LITERATURE

**CodeMark**  
CMNZ30084



<b>DRAWING SCALE</b> 1:2 @ A4	<b>ISSUE DATE</b> 11/02/2026
<b>DRAWING NUMBER</b> JSC 45CF VS81	<b>VERSION</b> 2.6

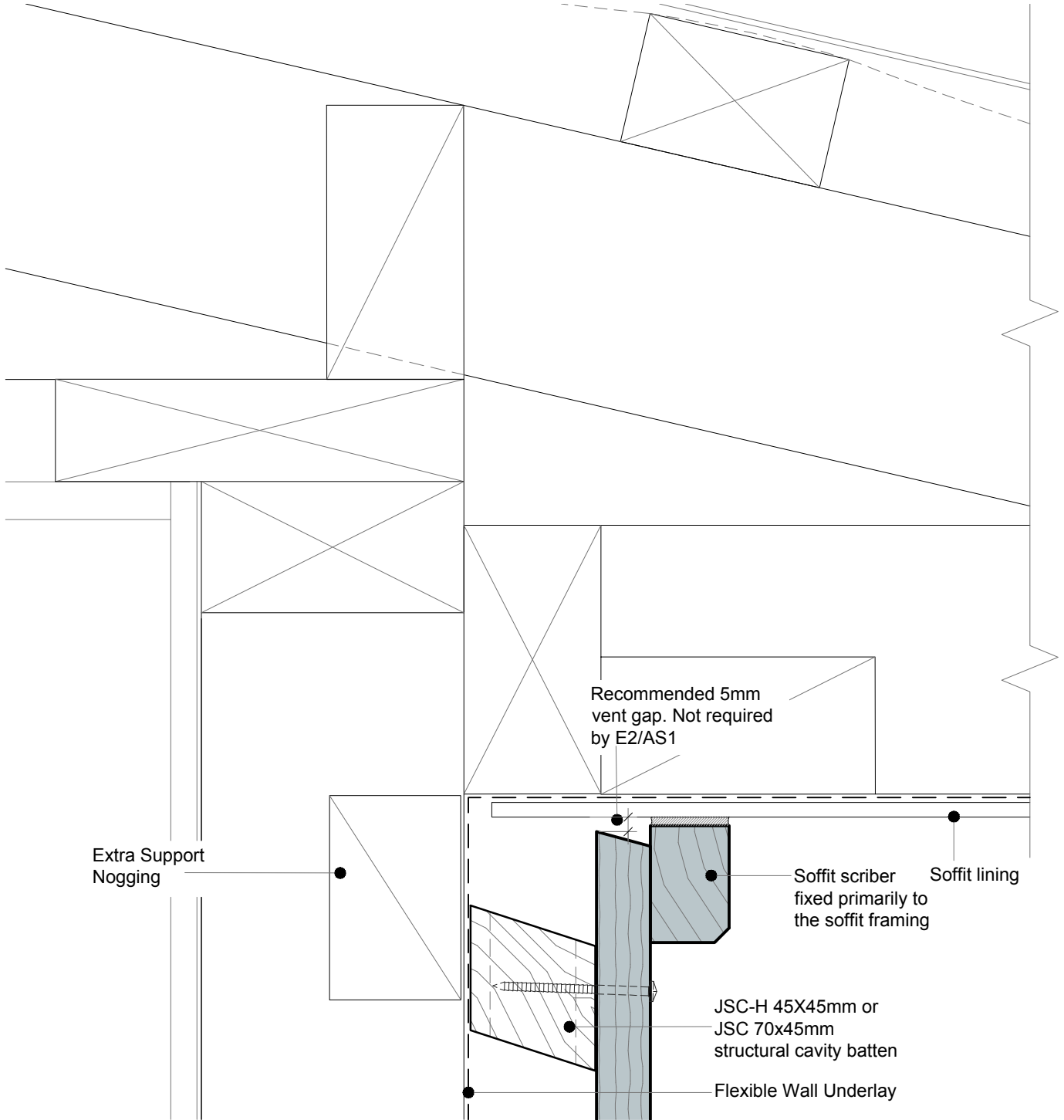

• TO BE READ IN CONJUNCTION WITH COMPLETE JSC VERTICLAD SYSTEM LITERATURE

**CodeMark**  
CMNZ30084



[jsc.co.nz](http://jsc.co.nz)  
TechHelp@jsc.co.nz | (09) 412 2812

**TYPE**  
VERTICAL SHIPLAP WB - 45mm CAVITY FIX

**NAME**  
Soffit Detail at Wall

• DETAILS MAY BE SUBJECT TO CHANGE WITHOUT NOTICE



SCAN IT FOR MORE INFORMATION

<b>DRAWING SCALE</b> 1:2 @ A4	<b>ISSUE DATE</b> 11/02/2026
----------------------------------	---------------------------------

<b>DRAWING NUMBER</b> JSC 45CF VS82	<b>VERSION</b> 2.6
--	-----------------------

Flashing Required When  
 1. Roof Pitch 10° or less  
 2. Soffit 100mm or less  
 3. Wind Zone VH or EH

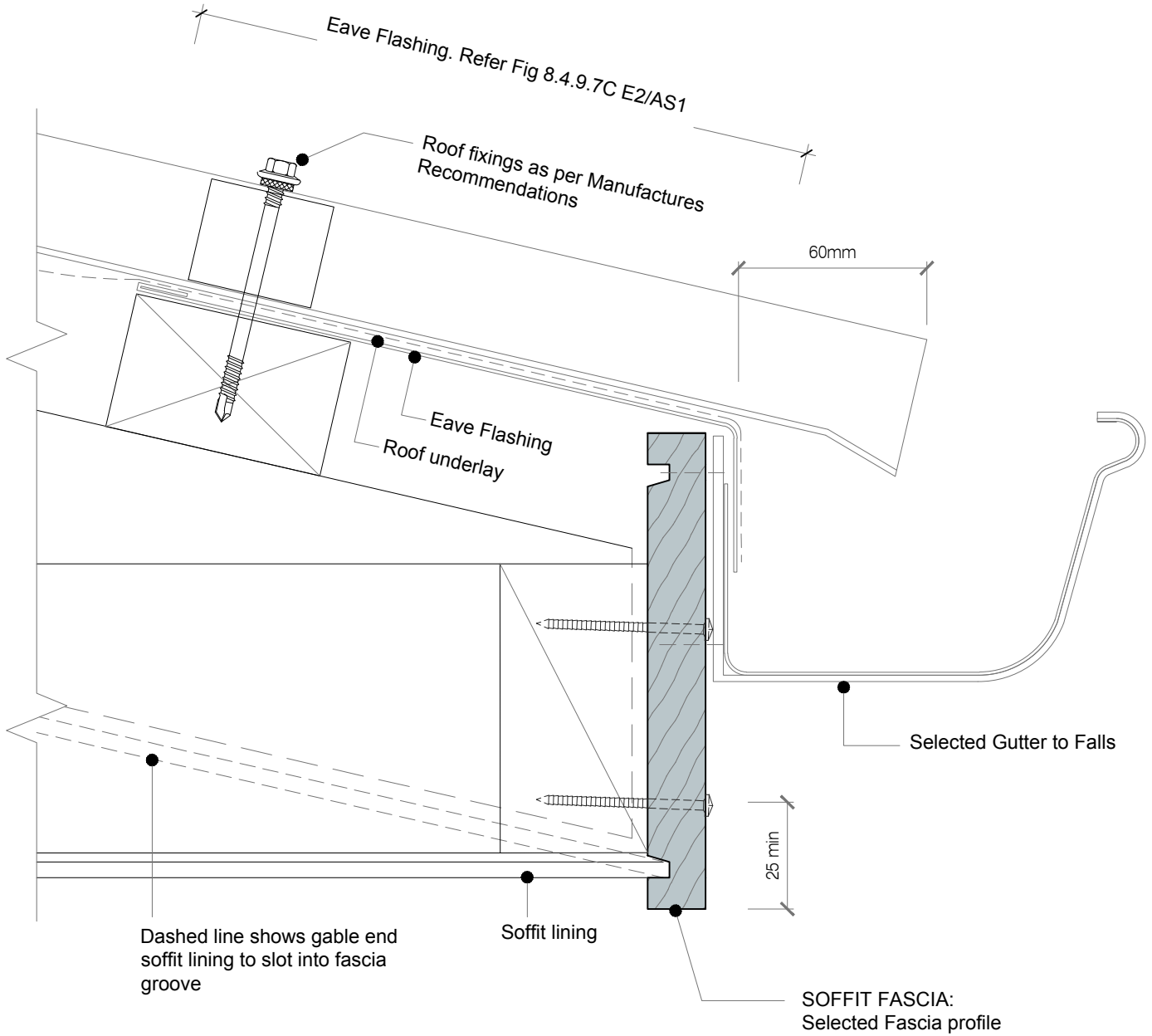

• TO BE READ IN CONJUNCTION WITH COMPLETE JSC VERTICLAD SYSTEM LITERATURE

**CodeMark**  
 CMNZ30084



jsc.co.nz  
 TechHelp@jsc.co.nz | (09) 412 2812

**TYPE**  
 VERTICAL SHIPLAP WB - 45mm CAVITY FIX

**NAME**  
 Soffit Detail at Fascia

• DETAILS MAY BE SUBJECT TO CHANGE WITHOUT NOTICE



SCAN IT FOR MORE INFORMATION

<b>DRAWING SCALE</b> 1:2 @ A4	<b>ISSUE DATE</b> 11/02/2026
<b>DRAWING NUMBER</b> JSC 45CF VS83	<b>VERSION</b> 2.6

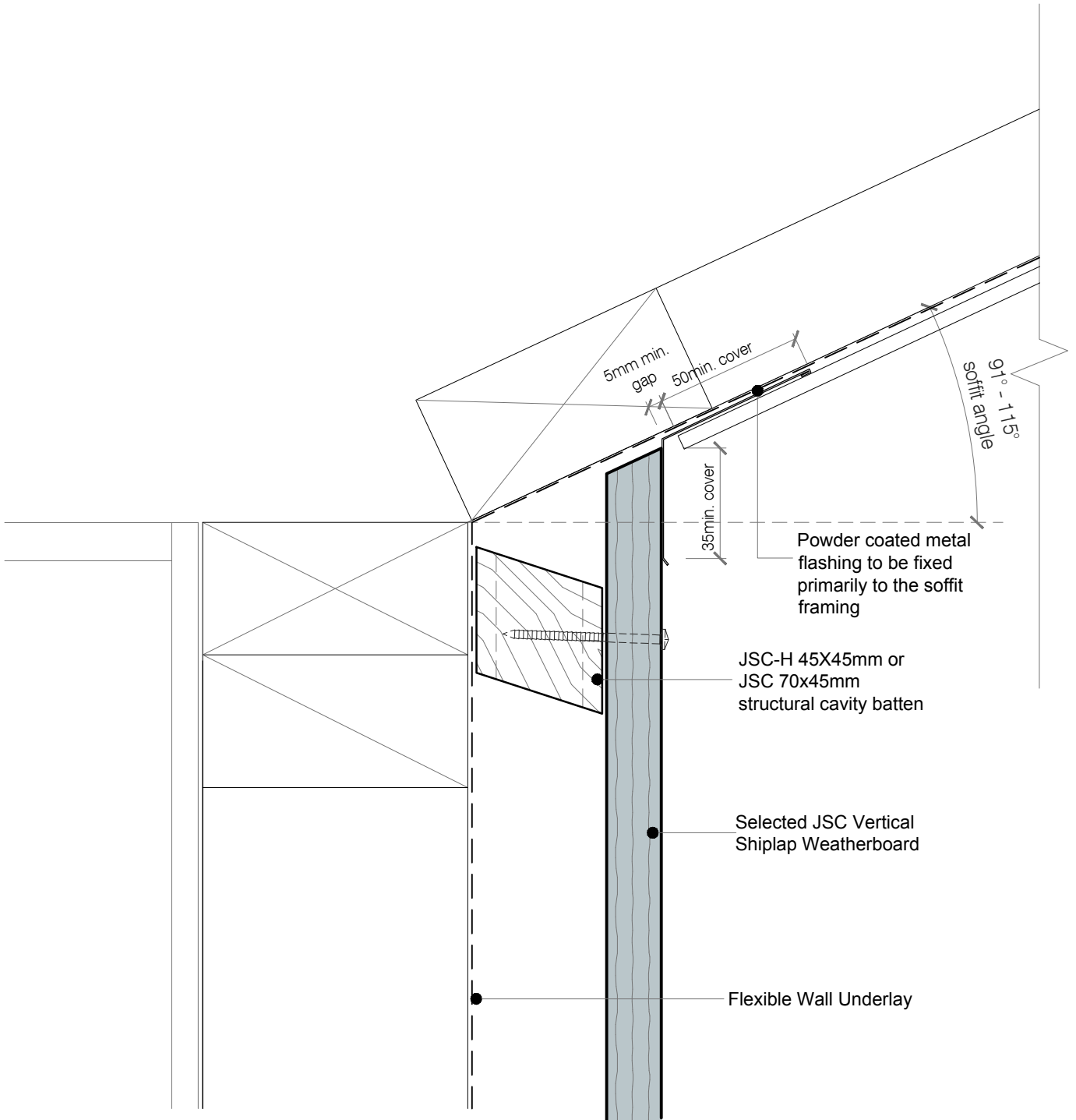

• TO BE READ IN CONJUNCTION WITH COMPLETE JSC VERTICLAD SYSTEM LITERATURE

**CodeMark**  
CMNZ30084



jsc.co.nz  
TechHelp@jsc.co.nz | (09) 412 2812

**TYPE**  
VERTICAL SHIPLAP WB - 45mm CAVITY FIX

**NAME**  
Raking Soffit Detail at Wall

• DETAILS MAY BE SUBJECT TO CHANGE WITHOUT NOTICE



SCAN IT FOR MORE INFORMATION

<b>DRAWING SCALE</b> 1:2 @ A4	<b>ISSUE DATE</b> 11/02/2026
----------------------------------	---------------------------------

<b>DRAWING NUMBER</b> JSC 45CF VS84	<b>VERSION</b> 2.6
--	-----------------------

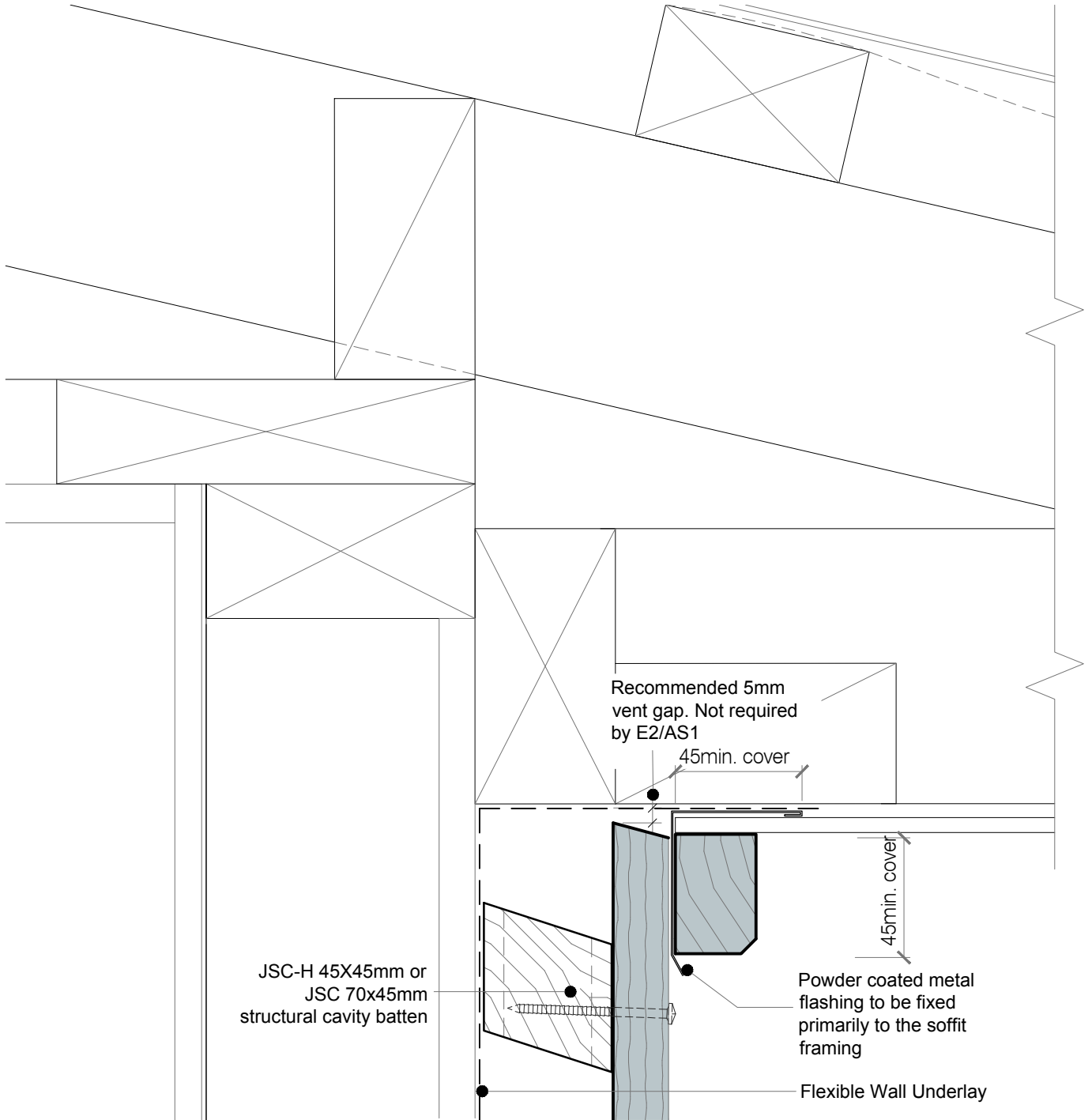

- DETAIL NOTES :
1. 45° max. fall along soffit junction
  2. Refer to BRANZ Build 158-27 - Build Right Soffit Details at Gable Verge

• TO BE READ IN CONJUNCTION WITH COMPLETE JSC VERTICLAD SYSTEM LITERATURE

**CodeMark**  
CMNZ30084

**JSC** PREMIUM ARCHITECTURAL & BUILDING SOLUTIONS

jsc.co.nz  
TechHelp@jsc.co.nz | (09) 412 2812

**TYPE**  
VERTICAL SHIPLAP WB - 45mm CAVITY FIX

**NAME**  
Gable Soffit Detail at Wall

• DETAILS MAY BE SUBJECT TO CHANGE WITHOUT NOTICE



SCAN IT FOR MORE INFORMATION

**DRAWING SCALE** 1:2 @ A4  
**ISSUE DATE** 11/02/2026

<b>DRAWING NUMBER</b> JSC 45CF VS85	<b>VERSION</b> 2.6
--	-----------------------

**Weatherboards:**

- Single fix at each cavity batten with annular grooved nails (stainless steel 316 or silicon bronze) as per NZBC E2/AS1 Table C.3.1.1
- Pre-drill holes approximately 1mm smaller than the nail gauge. Example: For a 75mm nail, use a 2.5mm drill
- Nailed with slight (2°+) upward slope
- Fixings to achieve a minimum of 35mm penetration into the cavity battens
- Minimum 50mm from the ends of boards
- Use an accurate packer in the negative detail. Do not rely on clinch nails for spacing

**Cavity battens**

- Will be fixed structurally to the framing. The fixings must achieve a minimum fixing tension of 1.8kN to 2.2kN. Refer to JSC Structural Cavity Batten fixing guide
- Must always be installed sloping away from the framing
- Must have a 5-10mm gap between them

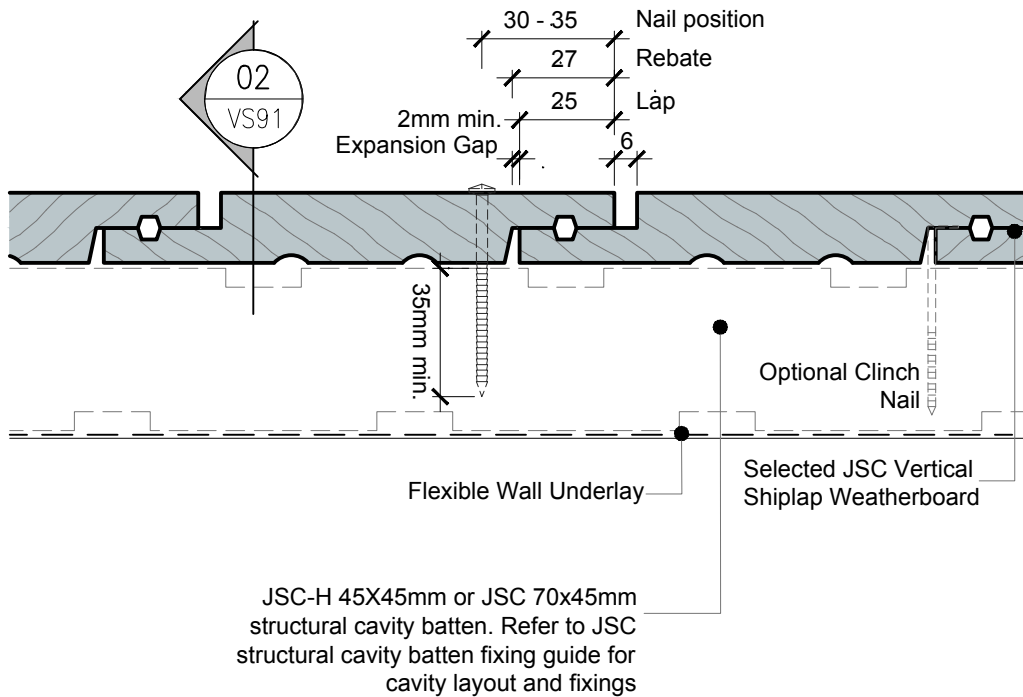

Plan Section 01

• TO BE READ IN CONJUNCTION WITH COMPLETE JSC VERTICLAD SYSTEM LITERATURE

**CodeMark**  
 CMNZ30084



<b>DRAWING SCALE</b> 1:2 @ A4	<b>ISSUE DATE</b> 11/02/2026
<b>DRAWING NUMBER</b> JSC 45CF VS90	<b>VERSION</b> 2.6

• DETAILS MAY BE SUBJECT TO CHANGE WITHOUT NOTICE

**Weatherboards:**

- Single fix at each cavity batten with annular grooved nails (stainless steel 316 or silicon bronze) as per NZBC E2/AS1 Table C.3.1.1
- Pre-drill holes approximately 1mm smaller than the nail gauge. Example: For a 75mm nail, use a 2.5mm drill
- Nailed with slight (2°+) upward slope
- Fixings to achieve a minimum of 35mm penetration into the cavity battens
- Minimum 50mm from the ends of boards
- Use an accurate packer in the negative detail. Do not rely on clinch nails for spacing

**Cavity battens**

- Will be fixed structurally to the framing. The fixings must achieve a minimum fixing tension of 1.8kN to 2.2kN. Refer to JSC Structural Cavity Batten fixing guide
- Must always be installed sloping away from the framing
- Must have a 5-10mm gap between them

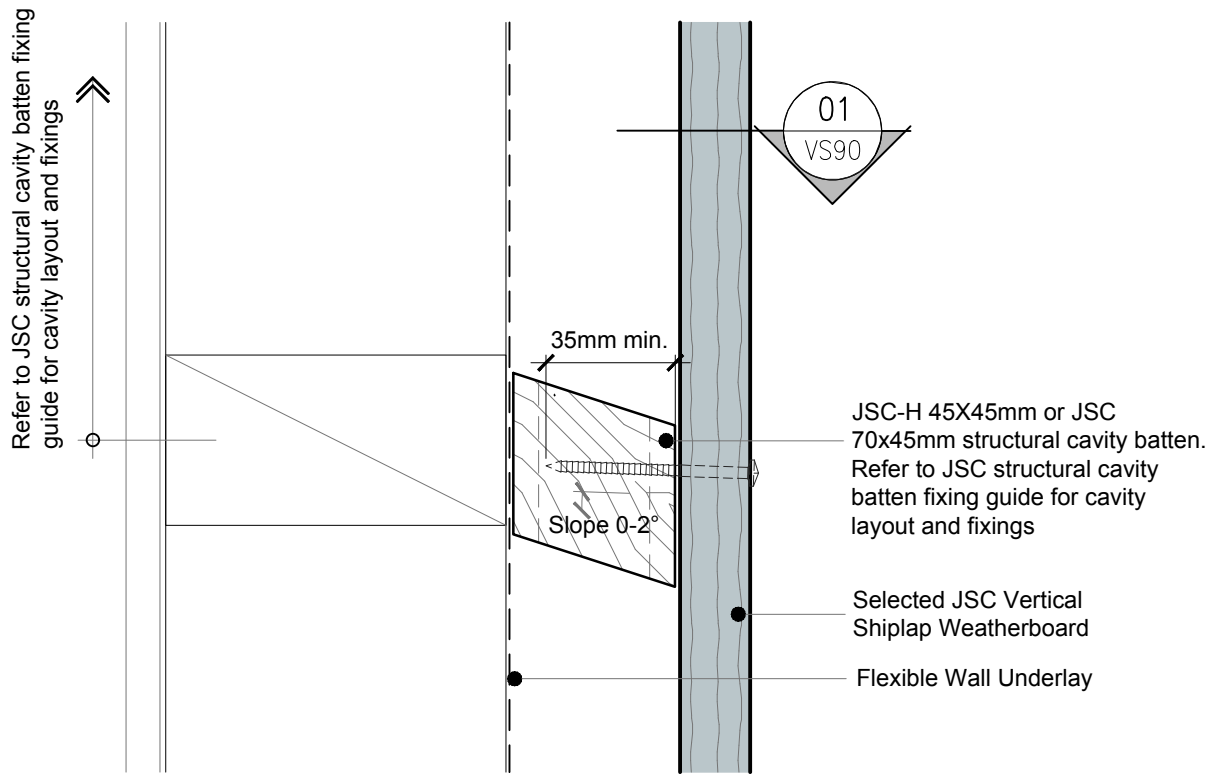

Cross Section 02

• TO BE READ IN CONJUNCTION WITH COMPLETE JSC VERTICLAD SYSTEM LITERATURE

**CodeMark**  
CMNZ30084



jsc.co.nz  
TechHelp@jsc.co.nz | (09) 412 2812

**TYPE**  
VERTICAL SHIPLAP WB - 45mm CAVITY FIX  
**NAME**  
Weatherboard Fixing - Cross Section

• DETAILS MAY BE SUBJECT TO CHANGE WITHOUT NOTICE



SCAN IT FOR MORE INFORMATION

<b>DRAWING SCALE</b> 1:2 @ A4	<b>ISSUE DATE</b> 11/02/2026
<b>DRAWING NUMBER</b> JSC 45CF VS91	<b>VERSION</b> 2.6

SEQUENCE :

- |                          |  |
|--------------------------|--|
| 1. Roof and Wall Framing | 8. Apron Flashing                          |
| 2. Wall Underlay         | 9. Wall Underlay (lap over Apron Flashing) |
| 3. Cavity Battens        | 10. Cavity Closure                         |
| 4. Transition Flashing   | 11. Cavity Battens (above Apron Flashing)  |
| 5. Fascia Board          | 12. Corner Flashing                        |
| 6. Roof Underlay         | 13. Cladding                               |
| 7. Roofing               | 14. Gutter                                 |

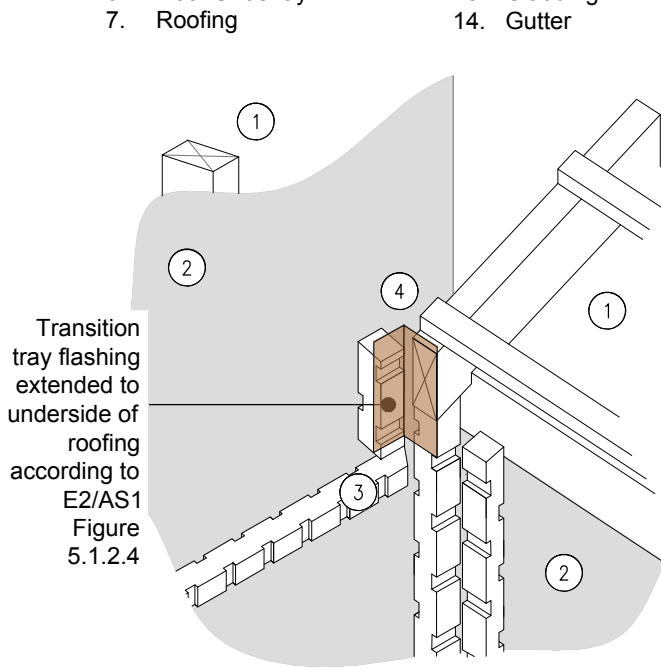

STAGE ONE

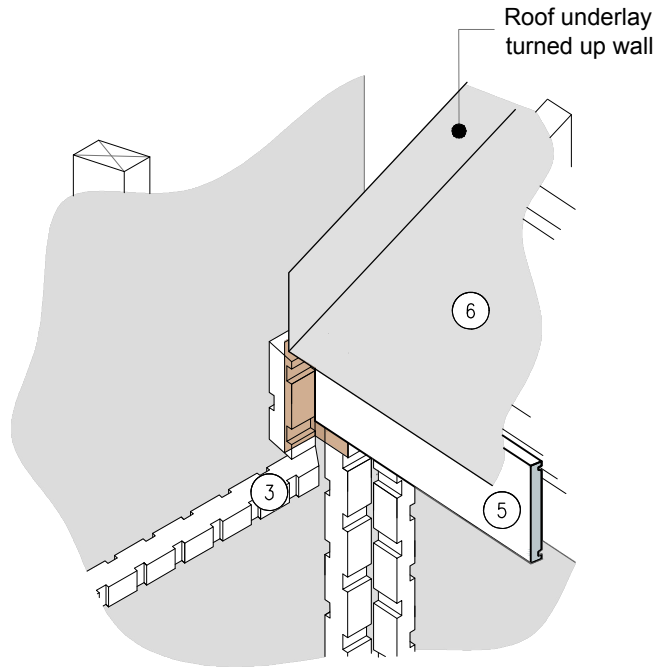

STAGE TWO

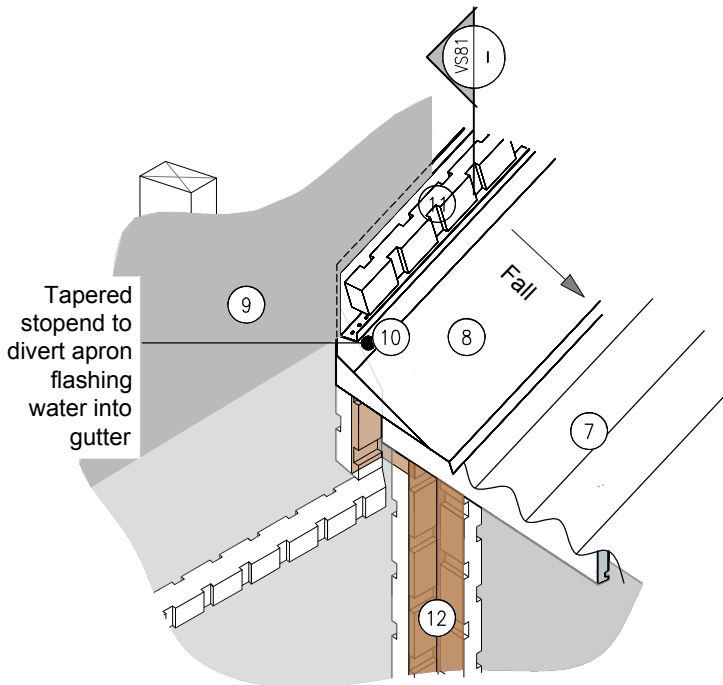

STAGE THREE

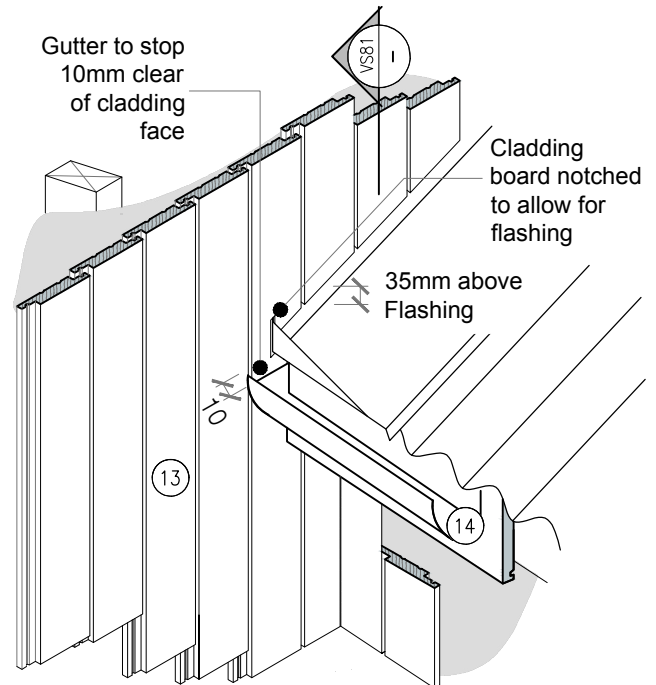

STAGE FOUR

• TO BE READ IN CONJUNCTION WITH COMPLETE JSC VERTICLAD SYSTEM LITERATURE

**CodeMark**  
CMNZ30084



<b>DRAWING SCALE</b> 1:2 @ A4	<b>ISSUE DATE</b> 11/02/2026
<b>DRAWING NUMBER</b> JSC 45CF VS92	<b>VERSION</b> 2.6