



## JSC CLIPP® BATTEN SYSTEM

For Interior Walls and Ceilings

Version 1.1 | November 2024



PREMIUM ARCHITECTURAL  
& BUILDING SOLUTIONS

featuring clip system by  grad®

## Contents

Introduction	3
Components	4
Batten Selection	6
Applications	7
Pre-Installation	7
Installation	8
Maintenance	11

# INTRODUCTION

Experience the seamless integration of form and function with the sustainably crafted JSC Clipp® Batten System. Featuring an aluminium rail with the Grad® patented clipping system, this solution offers a beautiful aesthetic while drastically simplifying the installation process. The sustainably sourced timber battens are the stand out feature of this system and are expertly profiled right here in New Zealand. JSC is proud to offer this exclusive system to assist architects, builders, and home owners alike.

## GENERAL

This guide covers the JSC Clipp® Batten System scope of use, storage, handling, fixing, finishing and maintenance guidelines, and installation guidance for fixing to internal timber-frame, lightweight steel-frame, and concrete walls, as well as timber-framed and steel rail ceilings.

The JSC Clipp® Batten System is comprised of:

- Grad® Aluminium Rails
- Grad® Clips
- JSC timber battens

JSC timber battens are available in a range of [species](#) and [profiles](#).

## SCOPE AND LIMITATION OF USE

The product is specifically crafted for non-structural applications with low imposed forces. The rail/timber batten can be fixed to diverse substrates, and it is the responsibility of the designer to consider additional factors such as fixing bracing, seismic considerations, building movement, and adherence to relevant standards in the overall design.

It's important to note that the system may not be appropriate for applications involving sports areas or playgrounds, where impact forces may occur. In such design scenarios, it is advisable to consult with a structural engineer for more detailed information and suitable design solutions.

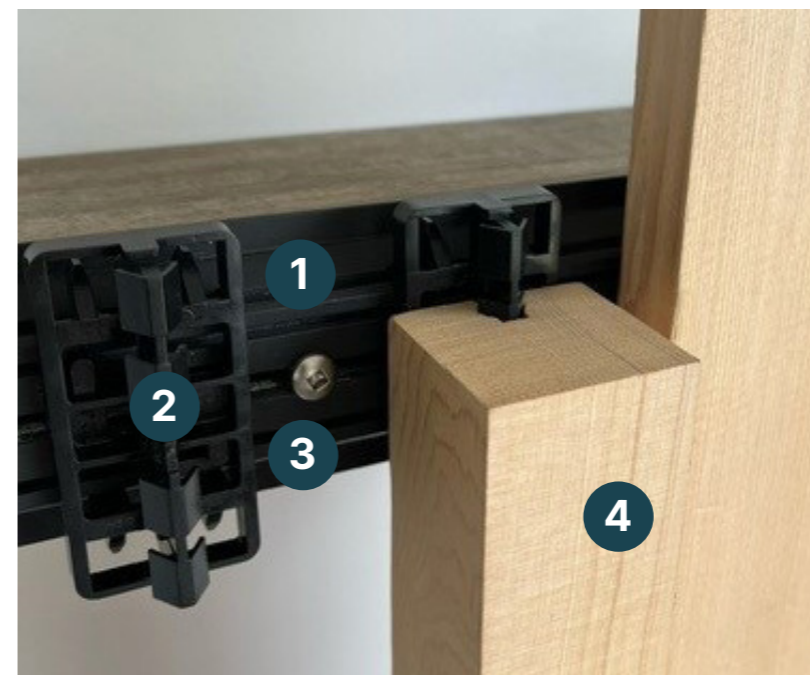

### 1 Grad® Flat Aluminium Rail

### 2 Grad® Clip

Polyoxymethylene (POM), an engineering thermoplastic. POM exhibits outstanding dimensional stability, rigidity, and high mechanical strength

### 3 Fixing

10g x 60mm Stainless Steel (A2-50) Pan Head screw (Refer to [Fixings](#))

### 4 Timber Batten

Sustainably sourced timber battens

Note: Interior lining and/or acoustic backing might be present but are not shown for clarification purposes.

# COMPONENTS

## GRAD® FLAT ALUMINIUM RAIL

Material	Aluminium EN AW-6060
Mass per meter of rail without clips	0,423 kg
Colour	Black
Thermal Treatment	T6
Tensile strength (MPa)	190
Tensile stress at yield (MPa)	150
Minimal elongation (%)	6
Tensile modulus (MPa)	70000
Coefficient of linear expansion (10 <sup>-6</sup> /K)	24
Fusion Temperature (°C)	585-655
Thermal conductivity (W/mK)	160



## GRAD® CLIP

Material	Polyoxymethylene
Density (kg/m <sup>3</sup> )	1410
Colour	Black
Tensile stress at yield (MPa)	64
Fusion temperature (°C)	190-220
Tensile modulus (MPa)	2850
Coefficient of linear expansion (10 <sup>-6</sup> /K)	110



Clips are spaced at 60mm or 80mm centres on the rail.

Available Rail lengths: 3960mm (60mm clip spacing) or 3920mm (80mm clip spacing)

## CLIP GRIP

Material	Hardened 301 stainless steel
Mass	4.2 g
Colour	Uncoated stainless steel
Conditioning	50
Reference	3142



Clip Grip prevents timber battens from sliding along clips and should be used in all installations.

## TIMBER BATTENS

Specie	
Western Red Cedar (Thuja plicata)	
Nordic Pine (Pinus Sylvestris)	
Western Hemlock (Tsuga Heterophylla)	
Radiata Pine (Pinus radiata)	
JSC TMT Thermally Modified Species	
TMT Taiga	
TMT Taxon	
TMT Tuscan	

Note: Other timber species may be available upon request. Talk to a JSC representative about specify project requirements

- **Finishes:** Depending on the species and application requirements, timber battens can be provided dressed, bandsawn, or brushed finishes.
- **Batten dimensions:** A select range of JSC timber species are available in combinations of 40×40, 90×18, 60×18, or 40×18 battens to achieve degrees of colour, texture or uniformity to complement your design context. Custom sizes are available on request.
- **Coating options:** JSC offers factory coatings for timber battens, and can offer fire-retardant coatings for interior applications, to ensure optimal performance and safety. For advice on selecting the appropriate product and finish for your project, please contact JSC.

# BATTEN SELECTION

## EXAMPLES OF POSSIBLE CONFIGURATIONS

### 3960mm long Rail - Clips at 60mm centres

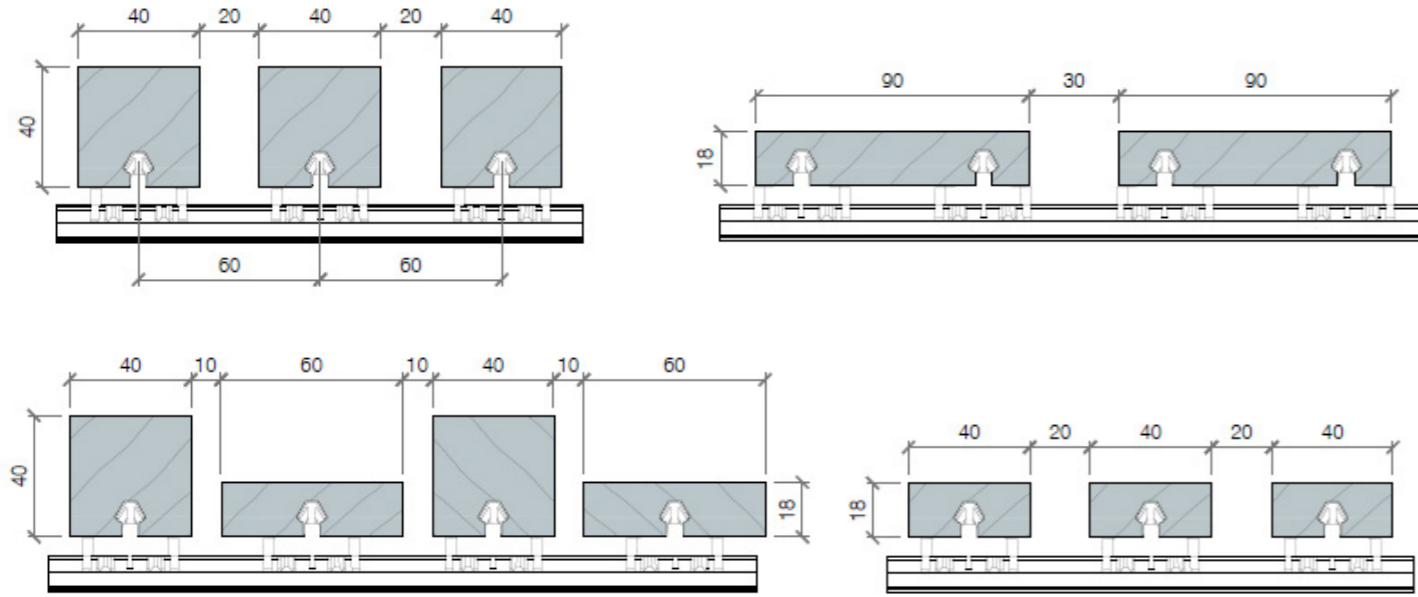

### 3920mm long Rail - Clips at 80mm centres

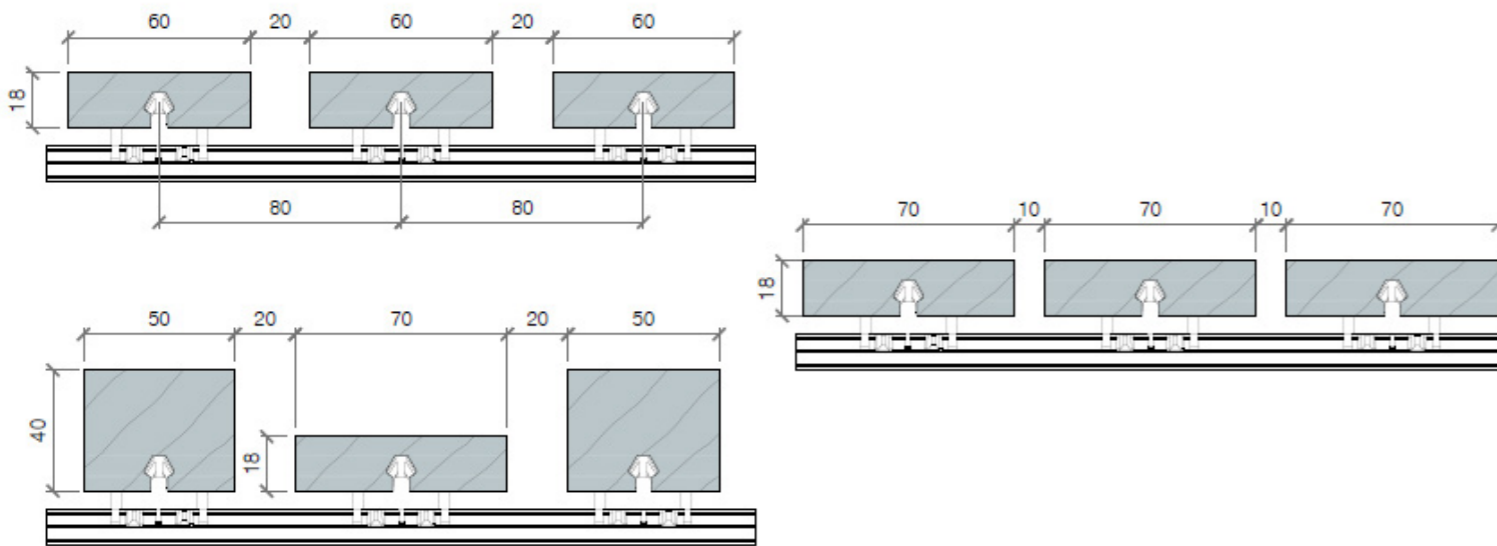

**NOTE:** Sizes may differ depending on the species.

# APPLICATIONS

WALLS	Substrate	Fixing
Battens can be installed vertically or horizontally. The rails must be installed perpendicular to the battens.  Rails to be fixed at 600mm maximum centres.  Walls to be max. 4m height.	Timber Frame	10g x 60mm Stainless Steel (A2-50) Pan Head screws @600mm crs max.
	Lightweight Steel Frame	10g x 45mm SDS (A2-50) Bugle Head screws @600mm crs max.
	Concrete (20mPa)	10g x 50mm Stainless Steel (A2-50) Pan Head screws with Ramplug DNP08 plastic plug @600mm crs max.

CEILING	Substrate	Fixing
Battens can be installed direct fixed to the ceiling structure or on a Steel rail.  Rails to be fixed at 600mm maximum centres.	Timber Frame	10g x 60mm Stainless Steel (A2-50) Pan Head screws @600mm crs max.
	Steel Rail (Rondo system)*	10g x 45mm SDS (A2-50) Bugle Head screws @600mm crs max.

\*For suspended ceiling applications, JSC recommends consulting your suspended ceiling manufacturer. The specifications of the system are determined by the weight of selected timber battens and the specific engineering requirements of your project.

# PRE-INSTALLATION

## DELIVERY, STORAGE, AND HANDLING

During transportation, it is essential to secure JSC Clipp rails in their original packaging and store them indoors before installation. Avoid storing in direct sunlight and do not place heavy objects on top of the rails to prevent damage and/or distortion.

When lifting and craning timber packets on-site, use appropriate equipment such as a forklift, crane forks, cradle, or spreader bars. In the absence of mechanical equipment, unload the product by hand. Never tip packets from the truck.

Do not lift or crane timber products with chains or straps unless the load is protected and pressure is widely distributed to prevent damage.

## HEALTH AND SAFETY

- Wear protective clothing and safety equipment such as safety glasses, gloves, long sleeves, and a mask, particularly when cutting aluminum.
- The installer is responsible for identifying and following all building codes and construction safety practices.

• For more information refer to [JSC Products - Site Health & Safety Information](#).

## MOISTURE MANAGEMENT

To minimize movement after installation, timber battens should be at or slightly below the room's equilibrium moisture content. Store the timber in the installation environment for at least five days before installing to equalise moisture content. In seasonally heated buildings, materials typically have a moisture content of 10-14%

# INSTALLATION

## WALLS

### Preparation:

- **Timber Framing:** Verify that the substrate is within the framing tolerances specified in NZS 3604:2011. Refer to Section 8 for detailed framing requirements.
- **Concrete Substrate:** Ensure compliance with NZS 3101:2006.
- **Lightweight Steel Framing:** Ensure compliance with NASH Standard Parts 1 and 2.
- For existing buildings, ensure the primary structure is suitable for the intended building work.

### Wall Setup:

- Ensure maximum distance between studs does not exceed 600mm.
- Orient timber battens parallel to studs; if not possible, install 70x45mm framing perpendicular to the rails.

### Rail Alignment and Installation:

- Cut rails to match wall height/length, leaving a 6mm gap between connected rails for aluminum expansion.
- When possible, cut the rail between two clips. However, if there is a clip where the cut needs to be, remove the clip using the [disassembly keys](#).
- Maintain maximum rail spacing of 600mm.
- Utilise a laser level or a plumbline to draw a vertical/horizontal reference line along the height/length of the wall, ensuring alignment of clips on subsequent rails.
- Ensure all rails are parallel to the first rail by referencing the drawn perpendicular line to align clips properly.
- If installing over concrete substrate, ensure a separation layer is used between concrete and the rails.

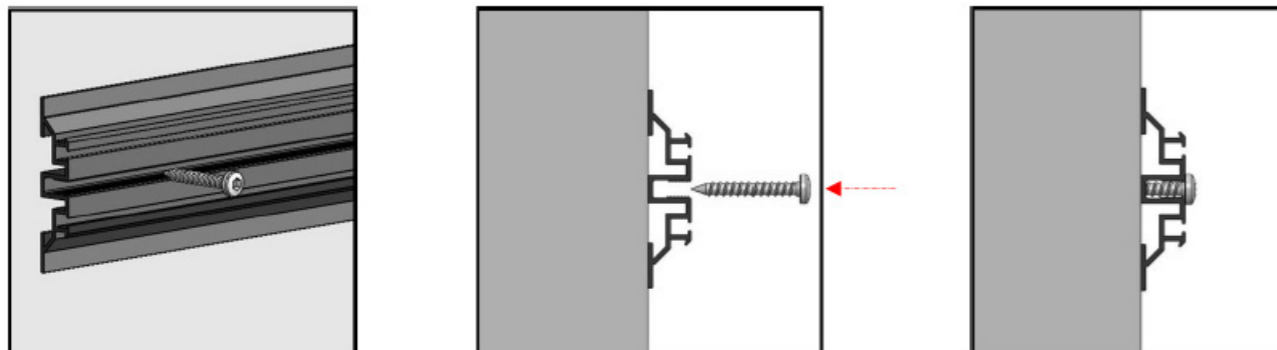

1. Install the rails spaced at 600mm maximum. Fix the rails to the substrate. Refer to the appropriate [fixings](#) and their spacings for different [substrates](#).

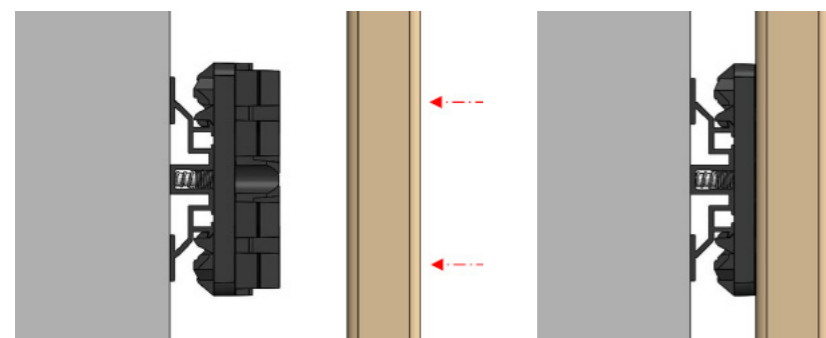

2. Install the timber battens

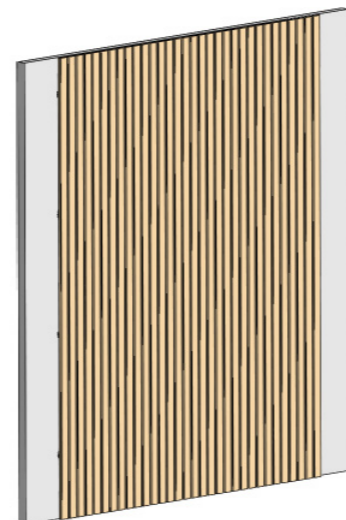

3. Finished wall

- Fix the rails to the [substrate](#) at max. 600mm centres with the appropriate [fixings](#).
- Once rails are positioned, install optional acoustic backing by sliding the bottom edge of the acoustic backing into the recess and slightly flexing the backing to ease the top edge under the clips and into the recess.

### Timber Battens Installation:

- Begin by clipping the battens onto the rails, starting from the bottom and working your way up.
- Press the first batten by hand onto the first clips at the bottom of the rails.
- Avoid using hammers or tools that could potentially damage the batten.
- Start the second row of battens above the first row, using the next set of clips, and repeat the process for subsequent rows.
- Leave a recommended gap of 3-5mm at

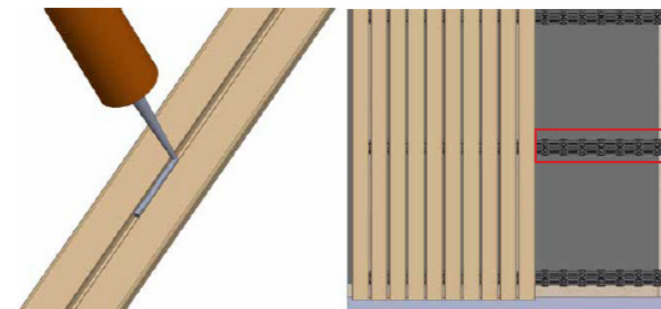

Method 1- Batten joint - glue in the grooves

the ends of the battens to allow for timber expansion.

Batten ends must meet on a rail. Where battens need to be joined there are two methods:

- **Method 1:** Apply a line of polyurethane wood glue in the grooves of the board (line to be the length of the clip) at the junction where the board meets the rail. This should be done on one of the rails positioned approximately in the middle of the board.
- **Method 2:** Place the polyurethane wood glue beads directly on the clip which is positioned on one of the rails located approximately in the middle of the batten.
- After completing one of these two steps, clip the battens onto the rails. All boards must be clipped to at least two rails to ensure effective fastening, except for the upper end of the roof gables.

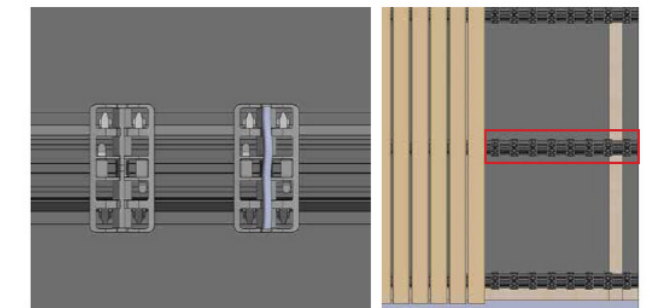

Method 2- Batten joint - glue on the clip

### Installation Considerations:

#### Clip Grip

- Install [Clip Grip](#) to prevent timber battens from sliding along the clips.
- Install one Clip Grip per timber batten.
- Position Clip Grip in the middle of the batten.
- If the batten is positioned on only two clips, place the Clip Grip at the bottom.
- Note: Clip Grip does not prevent battens from being removed.

# MAINTENANCE

## Interior Gable Walls:

- The maximum length allowed between the edge of the outermost rail and the end of the batten is 200mm.

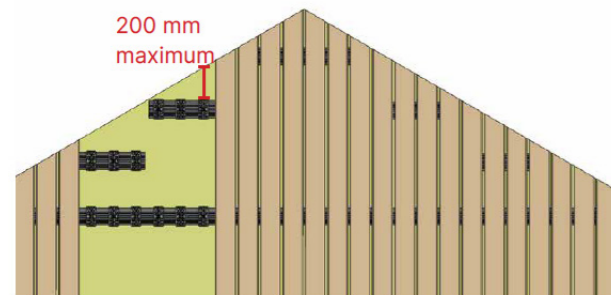
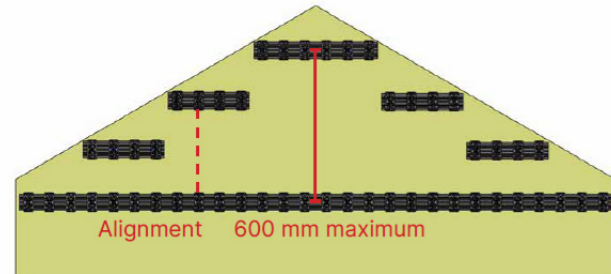

Vertical Battens on Gable wall

- Sections of the rails must be cut and positioned between the main rails to offer extra support. During the installation of these additional support rails, it is essential to ensure that the clips are aligned with those on the other rails.

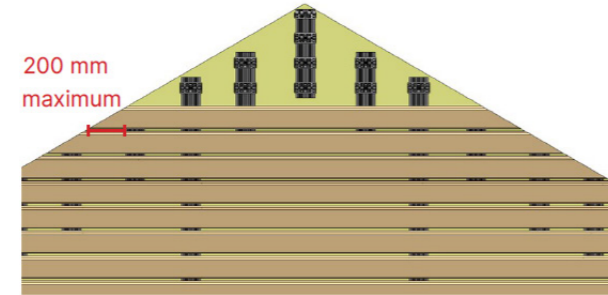
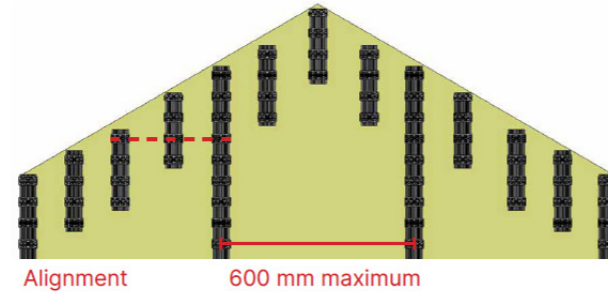

Horizontal Battens on Gable wall

After installation, if a batten needs to be removed, use the [disassembly keys](#) provided.

## CEILINGS

### Preparation:

- Ensure the substrate is within the framing tolerances specified in NZS 3604:2011.
- Refer to NZS 3604:2011 Section 13 for framing requirements.
- For existing buildings, ensure the primary structure is suitable for the intended building work.

### Framing Setup:

- Ensure joists/trusses or roof structure are running the same way as the battens. If not, install 70×45mm framing perpendicular to the rails, following the same direction as the decorative battens.

### Rail Alignment and Installation:

- Utilise a laser level or a plumbline to draw a reference line, ensuring alignment of the clips of subsequent rails.
- All rails should be parallel to the first rail. Use the reference line to ensure proper alignment of all clips for each rail.
- Maintain a maximum rail spacing of 600mm centres for ceiling applications.
- Secure the rails to the framing at 600mm max. centres using the appropriate [fixings](#).
- Instructions regarding cutting the rails, positioning them, using Clip Grip, clipping on the timber battens and joining the battens if necessary are the same as for [walls installations](#).

## REPLACEMENT AND REMOVAL OF BATTENS

It is possible to remove a batten with the dismantling keys.

The keys must be placed according to the diagram and slide until they are positioned between the clip and the rail. By turning in the opposite direction of the arrows, the boards can be unclipped. The space between each board must be at least 4 mm to be able to insert the keys.

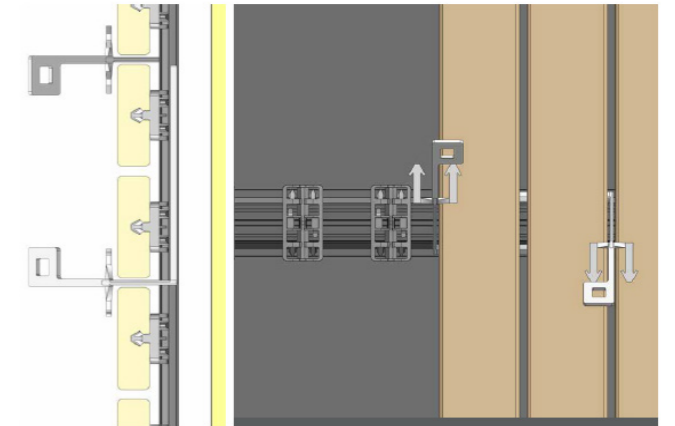

## CARE AND MAINTENANCE

- Regularly sweep with a soft anti static mop to prevent dust buildup.
- Immediately wipe up spills with a dry cloth; for persistent marks, use a soft damp cloth and wipe in the direction of the timber's natural grain, avoiding vigorous rubbing and scrubbing.
- Do not use detergents, chemicals, or other abrasive substances as they can cause permanent damage to timber and coatings.
- Avoid placing timber in areas with extreme humidity, as moisture may cause expansion.

**Disclaimer:** This installation guide aims to provide comprehensive information to aid designers, builders, and owners in the effective execution of their projects. It is important to note that not all project types, design requirements, and installation scenarios are covered herein. The JSC team is readily available to help with project-specific solutions.

The product recommendations outlined in this manual serve as general guidelines, offering insights into the system's functionality. These recommendations are intended for technically competent individuals. Given the diverse nature of project-specific requirements, designers are advised to conduct all necessary engineering verification checks before installation.

Designers, builders, and owners are responsible to ensure that the information on this manual is current by referring to our website: [jsc.co.nz](http://jsc.co.nz).

Please be aware that JSC reserves the right to modify existing specifications and discontinue products without prior notice.

JSC's contracts are supply-only, we often lack context regarding the final product application or engineering specifications. Consequently, we cannot guarantee or be held liable for ensuring the "fit for purpose" aspect in any given project.

JSC accepts no liability or responsibility for the improper installation of this product.



PREMIUM ARCHITECTURAL  
& BUILDING SOLUTIONS

[jsc.co.nz](https://jsc.co.nz)

[TechHelp@jsc.co.nz](mailto:TechHelp@jsc.co.nz) | [Sales@jsc.co.nz](mailto:Sales@jsc.co.nz)

FIND JSC ONLINE



**AUCKLAND**

(09) 412 2800  
22 Sawmill Road  
Riverhead

**HAMILTON**

0800 57 26 88  
43 McKee Street  
Pukete

**WELLINGTON**

0800 57 26 88  
61 Seaview Road  
Seaview

**CHRISTCHURCH**

(03) 348 9726  
23 William Lewis Drive  
Sockburn